

SIGNPRO[®]

S Y S T E M S

// VOLUME 8 WAYFINDING SIGN SYSTEMS

17"
frame dimension

18.19"

17-15/16"

graphic dimension

2019 ISSUE 1

THE SIGN MAKERS'[®]
**HAND
BOOK**
WAYFINDING SYSTEMS

TABLE OF CONTENTS

■ FLAT WAYFINDING

WALL SIGNS	3
DIRECTORIES	8
PROJECTING SIGNS	10
SUSPENDED SIGNS	12
TRIANGULAR SIGNS	13
DESK FRAMES	13

■ CURVED WAYFINDING

WALL SIGNS	15
DIRECTORIES	18
PROJECTING SIGNS	22
SUSPENDED SIGNS	24
TRIANGULAR SIGNS	26
DESK FRAMES	27

■ SNAPPING SOLUTIONS

POSTER FRAMES	30
PROJECTING	32
SUSPENDED	33

■ STANDING SIGN SOLUTIONS

PYLONS & INFO CENTERS	35
-----------------------	----



Introducing: FLAT SYSTEM

- //Modern Flat Shape
- //Round or Square Profile
- //Black or Silver
- //Customized Options

Perfect systems for directional guidance in offices, hospitals, retails, schools to help visitors navigate through the building with ease.

SignPro Systems® (SPS) provides affordable, modular wayfinding signage to the trade. From wall frames to self-standing pylon directories and everything in between, SignPro offers the directional indoor signage your clients need. SPS is proud to boast ever-increasing custom capabilities; we can build frames and signs suited to your exact specifications.



CURVED SYSTEM

- //Sleek Curved Shape
- //Black or Silver or combination thereof
- //Customized Options

SignPro frames accommodate a multitude of sign substrates, from printed paper inserts mounted with your protective lens, to laminated prints, cut vinyl, photopolymer, ADA faces, engraved plastics, metal and more. We ensure to work with you based on the material best suited for the project.

Made in the **USA** // **AFFORDABLE** // **FAST**

INTRODUCTION



FLAT SYSTEM

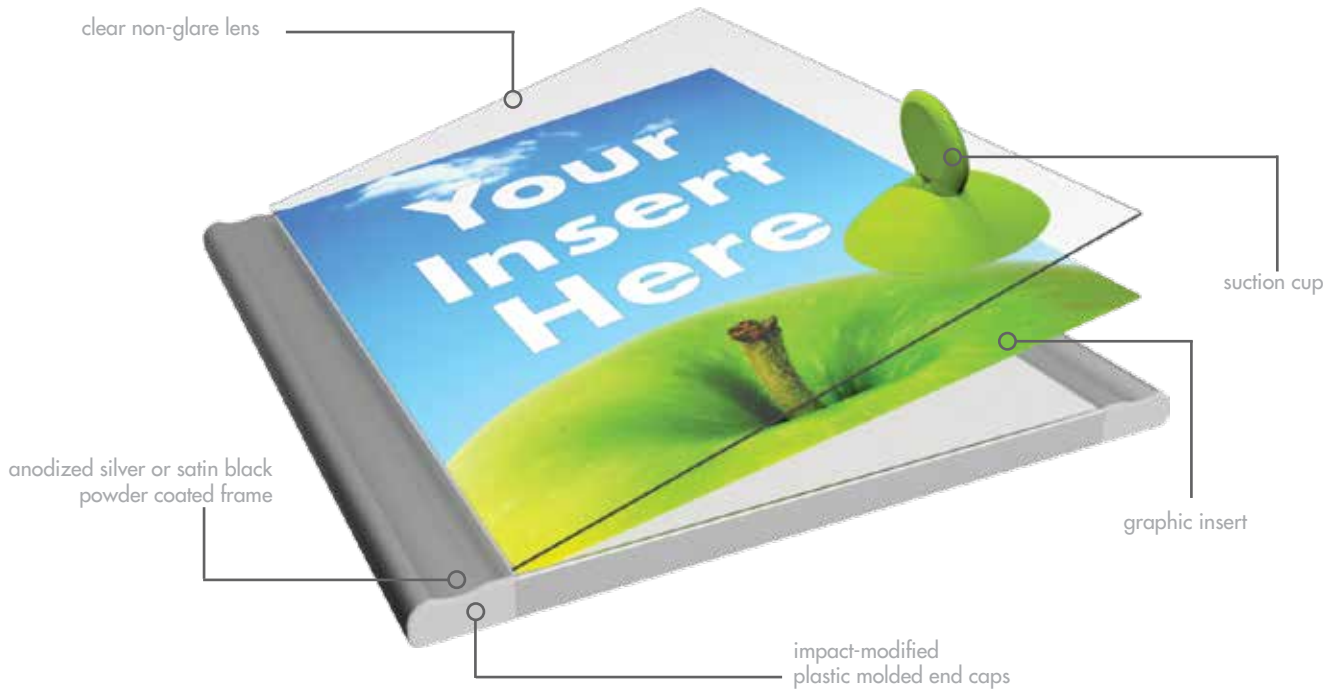

- \\ Aluminum frame extrusions are offered from 6" to 32" wide, at varying heights
- \\ Frames include round or square-shaped profile
- \\ Frames are available in anodized silver or powder-coated black
- \\ Plastic end caps are offered in gray or black
- \\ Frames come standard with a clear, non-glare lens
- \\ Tape mounting included, holes are an additional cost
- \\ Custom lengths available

■ Frame Size ■ Graphic Dims ■ Visible Area PREFIX: Add "FLAT-" to each listed code

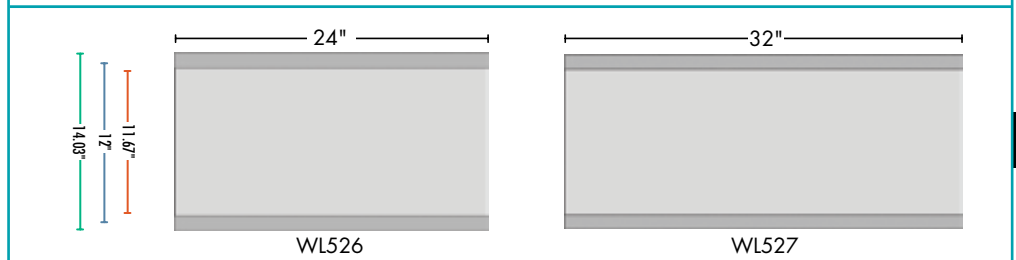
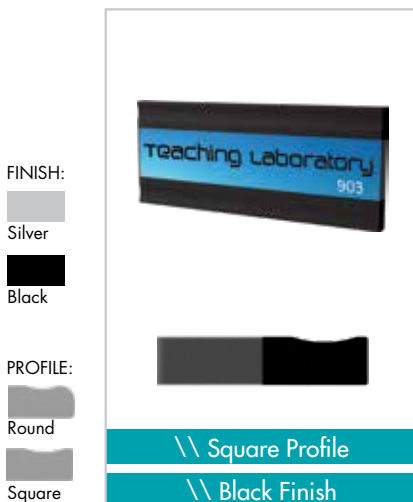
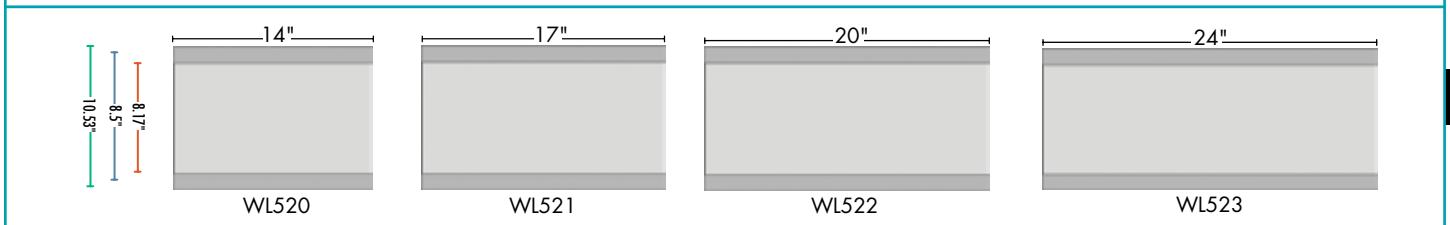
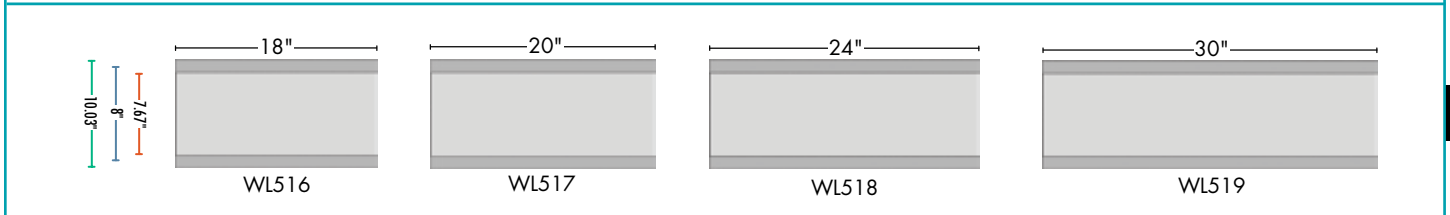
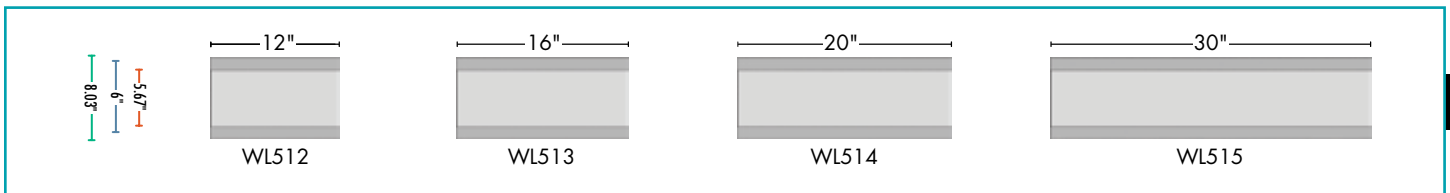
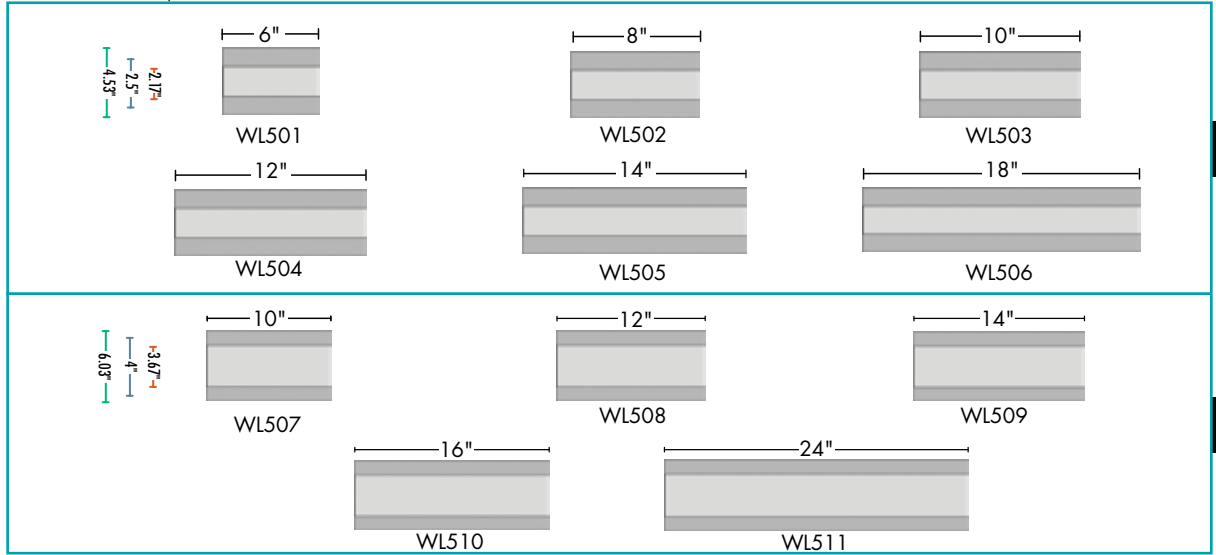

2.5

4

6

8

LETTER

11

12



FINISH:

Silver

Black

PROFILE:

Round

Square

■ Frame Size ■ Graphic Dims ■ Visible Area PREFIX: Add "FLAT-" to each listed code

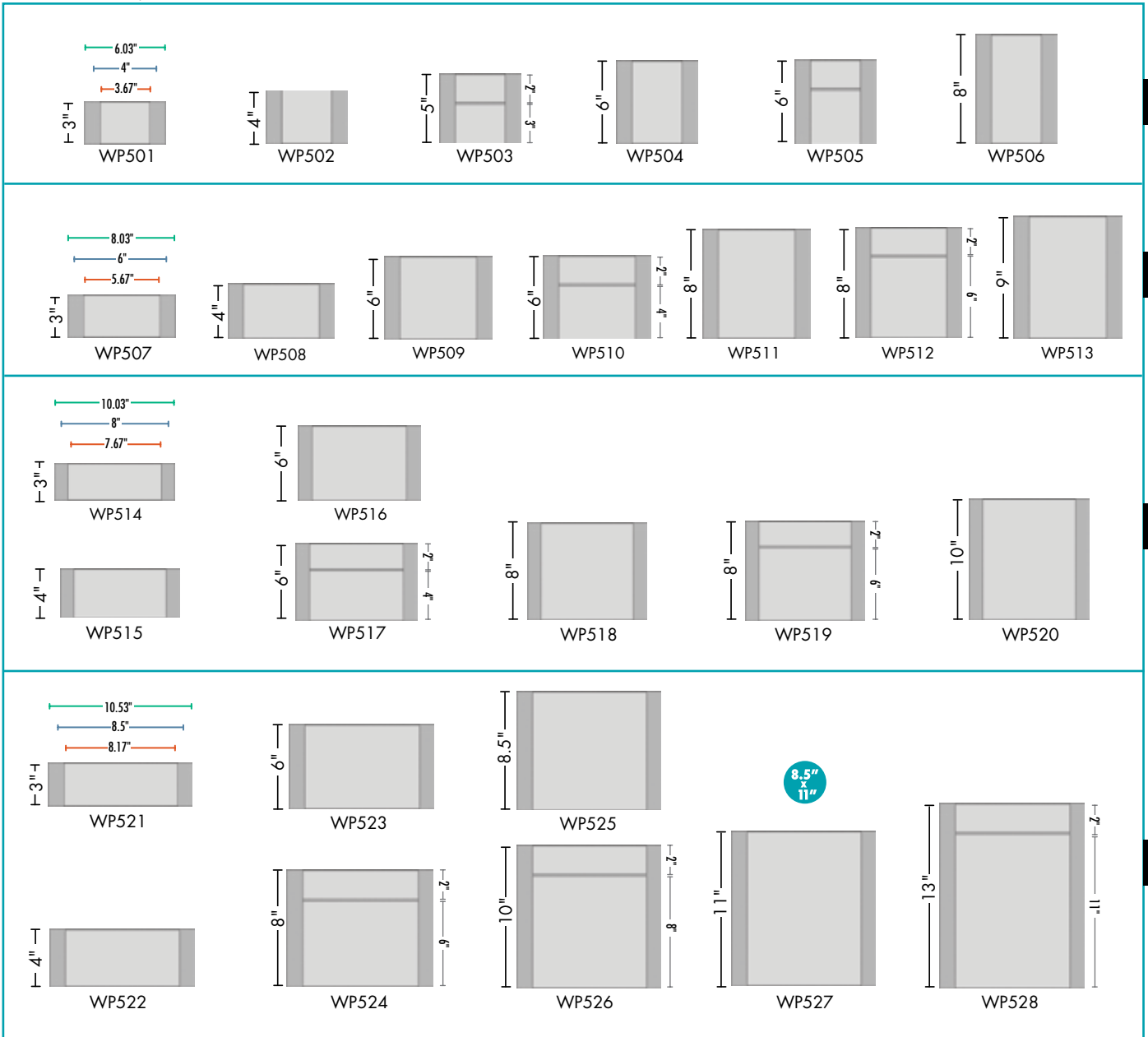

■ Frame Size ■ Graphic Dims ■ Visible Area

PREFIX: Add **"FLAT"** to each listed code

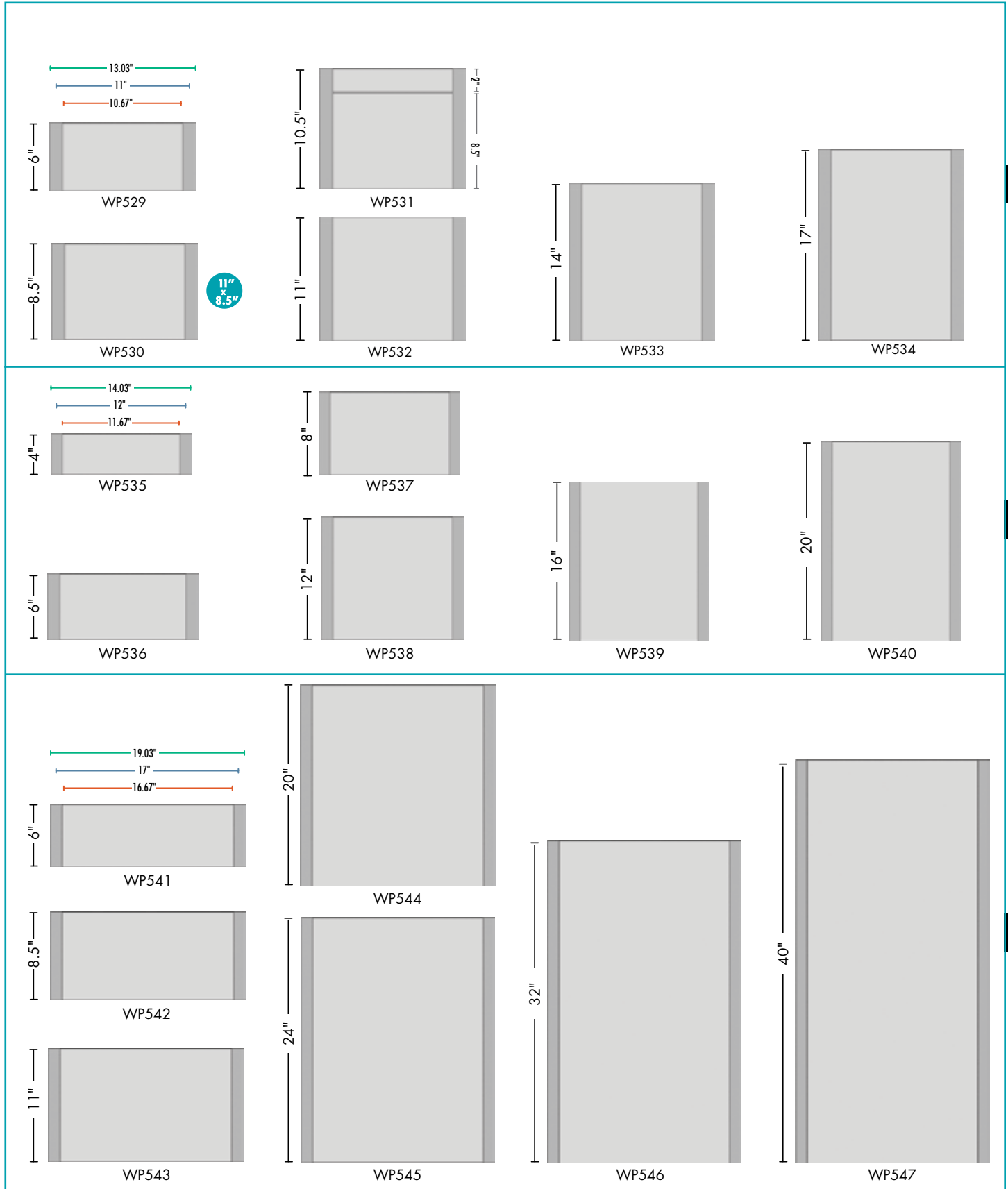

11

12

17

**LEFT & RIGHT
WALL SIGNS**

■ Frame Size ■ Graphic Dims ■ Visible Area

PREFIX: Add "FLAT-" to each listed code

20

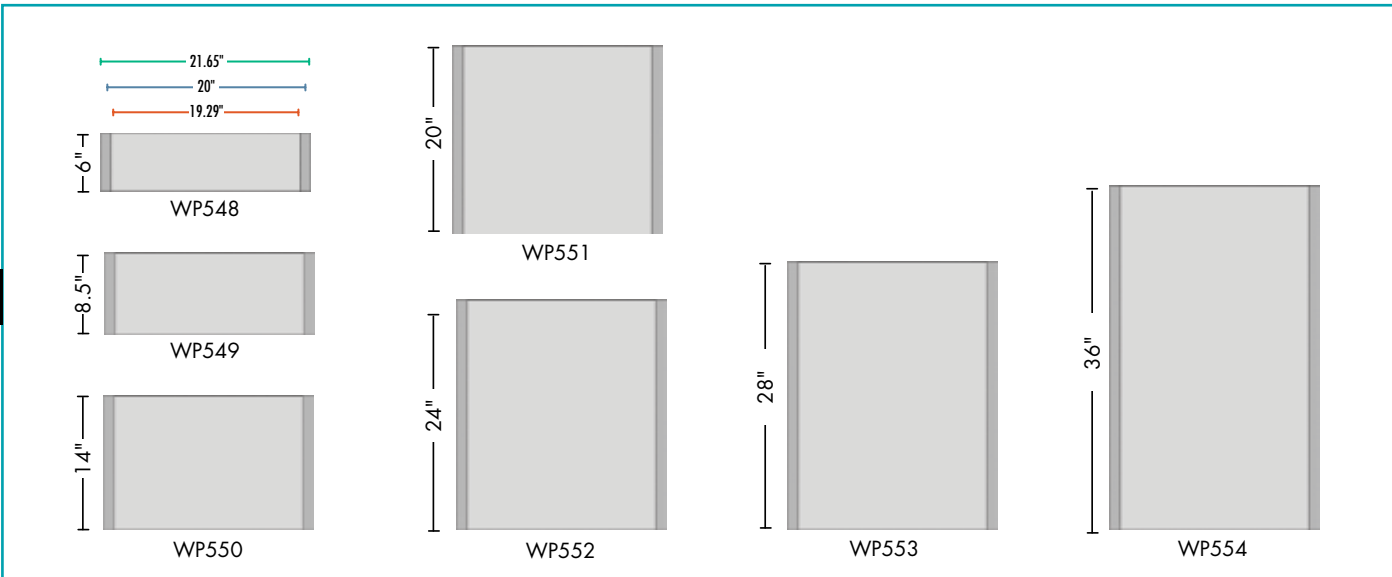

24

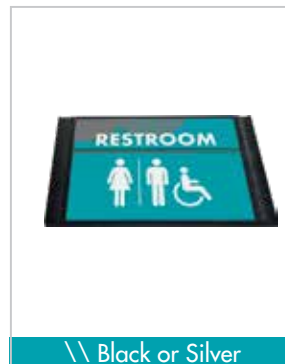
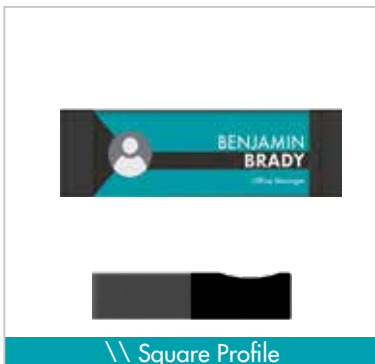
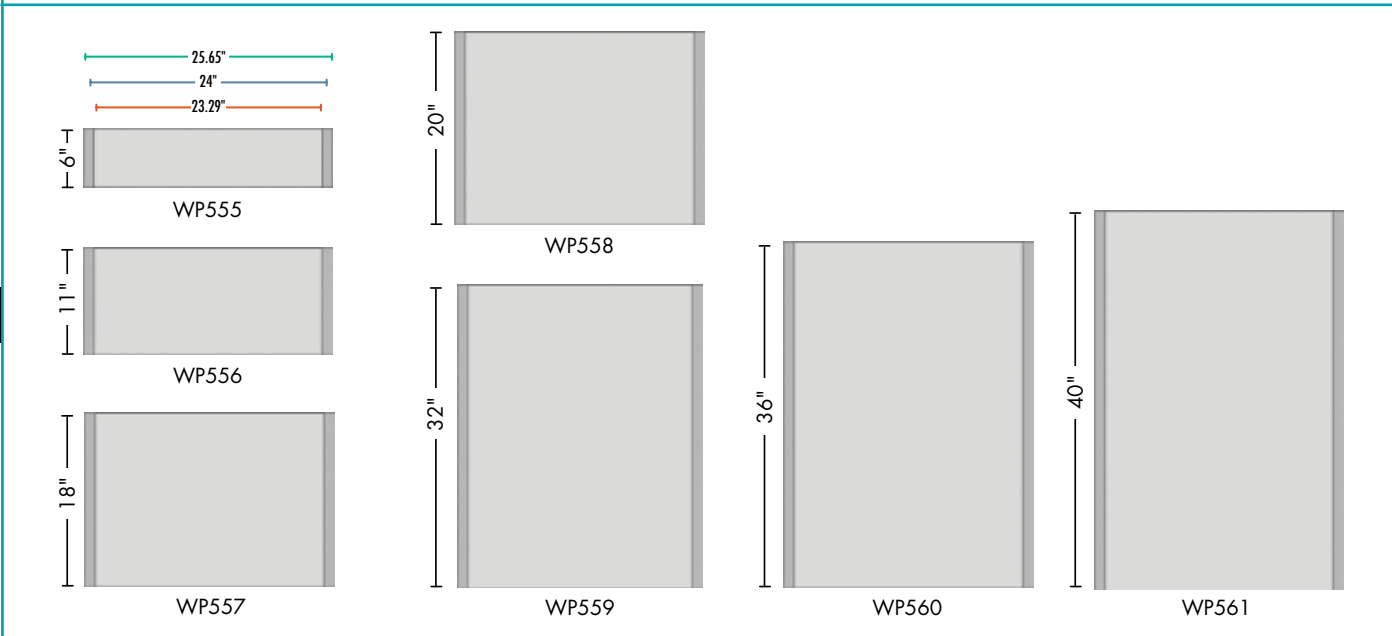

FINISH:



PROFILE:

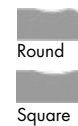



PORTRAIT
DIRECTORIES

■ Frame Size ■ Graphic Dims ■ Visible Area

PREFIX: Add "FLAT-" to each listed code

11

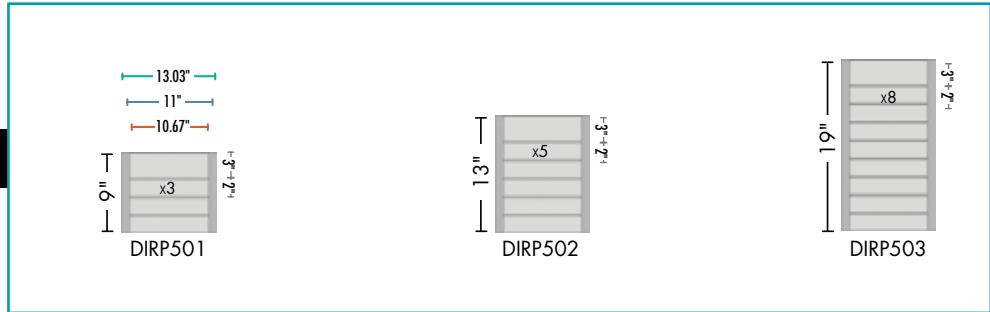

17

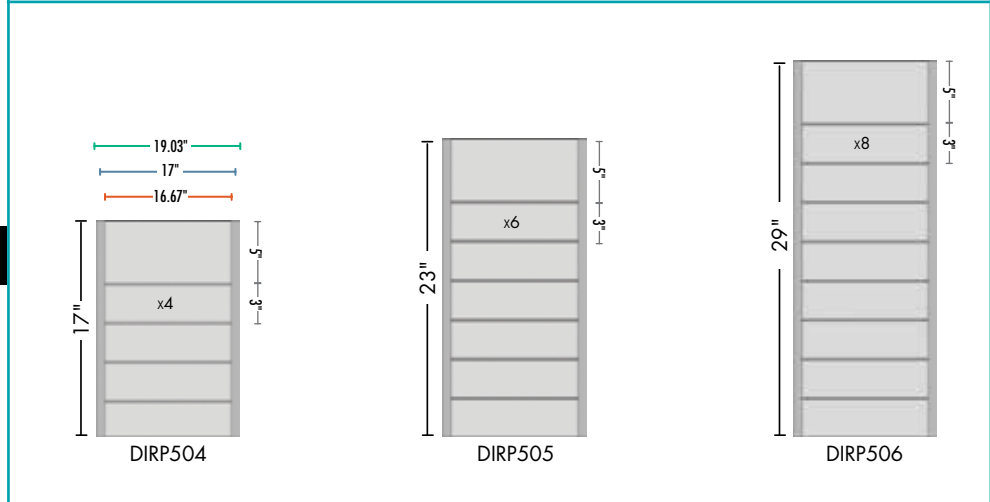

24

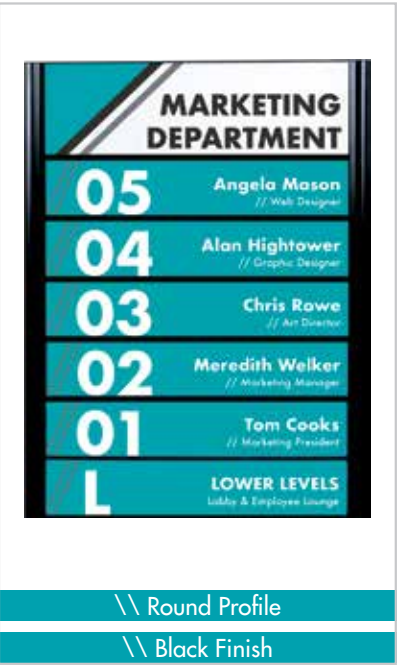
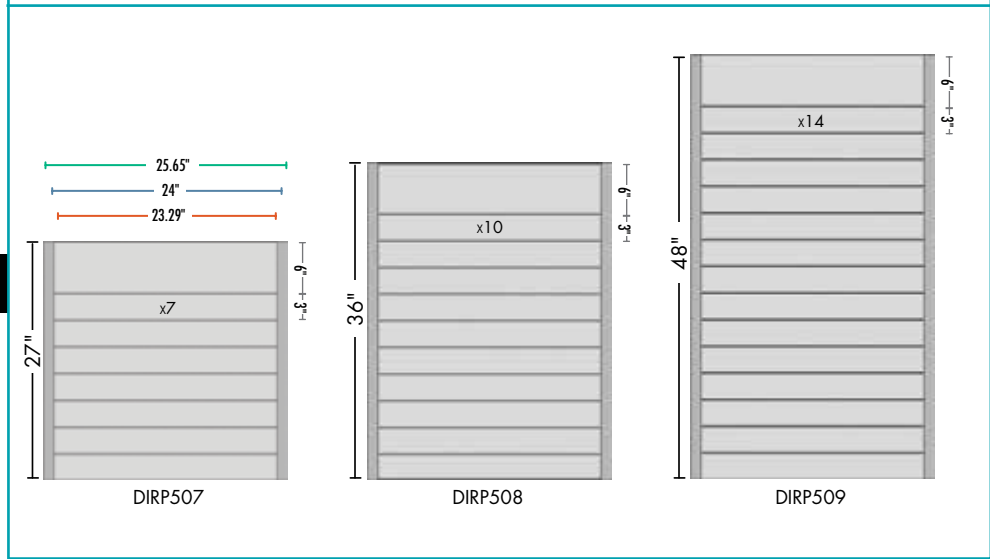

\\ Round Profile
\\ Black Finish



\\ Round Profile
\\ Silver Finish

- \\ Portrait style frame shape offered in choice of round or square-shaped
- \\ Frames located on the left & right sides
- \\ Configure the directory header to be placed as desired
- \\ Frame color choice of anodized silver or black
- \\ Dividing strips & end caps match the frame color of choice
- \\ Inserts can be replaced individually
- \\ Custom sizes available

FINISH:

Silver

Black

PROFILE:

Round

Square



11

17

24

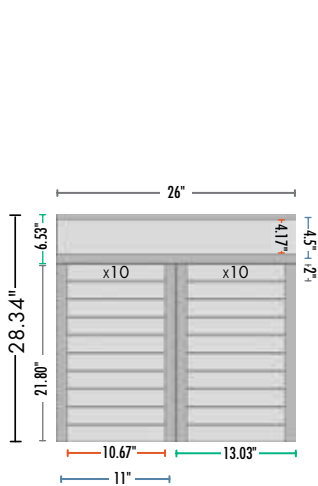

DIRM501

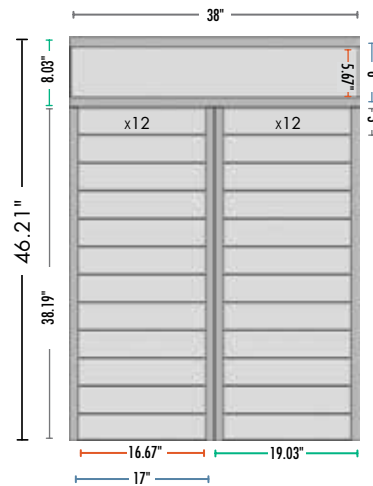

DIRM502

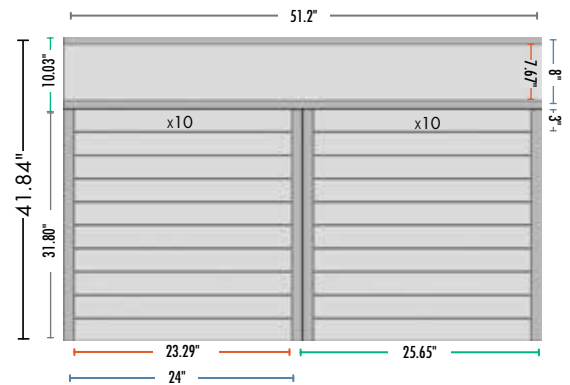

DIRM503

■ Frame Size ■ Graphic Dims ■ Visible Area

PREFIX: Add "FLAT-" to each listed code

- \\ Combine multiple frames with a top & bottom header
- \\ Frames located on the left & right sides below the header
- \\ Frame color choice of anodized silver or black
- \\ Dividing strips & end caps match the frame color of choice
- \\ Inserts can be replaced individually
- \\ Custom sizes available

TOP & BOTTOM

PROJECTING

■ Frame Size ■ Graphic Dims ■ Visible Area PREFIX: Add "FLAT-" to each listed code

4	<p>PJL501</p>	<p>PJL502</p>
	<p>PJL503</p>	<p>PJL504</p>
8	<p>PJL505</p>	<p>PJL506</p>
	<p>PJL507</p>	<p>PJL508</p>
11	<p>PJL509</p>	<p>PJL510</p>

- \\ Double-sided flat projecting frames in landscape orientation
- \\ Frames located on top & bottom offered anodized in silver or black
- \\ Frames offered in choice of round or square-shaped
- \\ End caps match the frame color of choice
- \\ Inserts can be replaced
- \\ Comes with non-glare lens, fully assembled
- \\ Custom sizes available



FINISH:
 ■ Silver
 ■ Black

PROFILE:
 ■ Round
 ■ Square

■ Frame Size ■ Graphic Dims ■ Visible Area PREFIX: Add "FLAT-" to each listed code

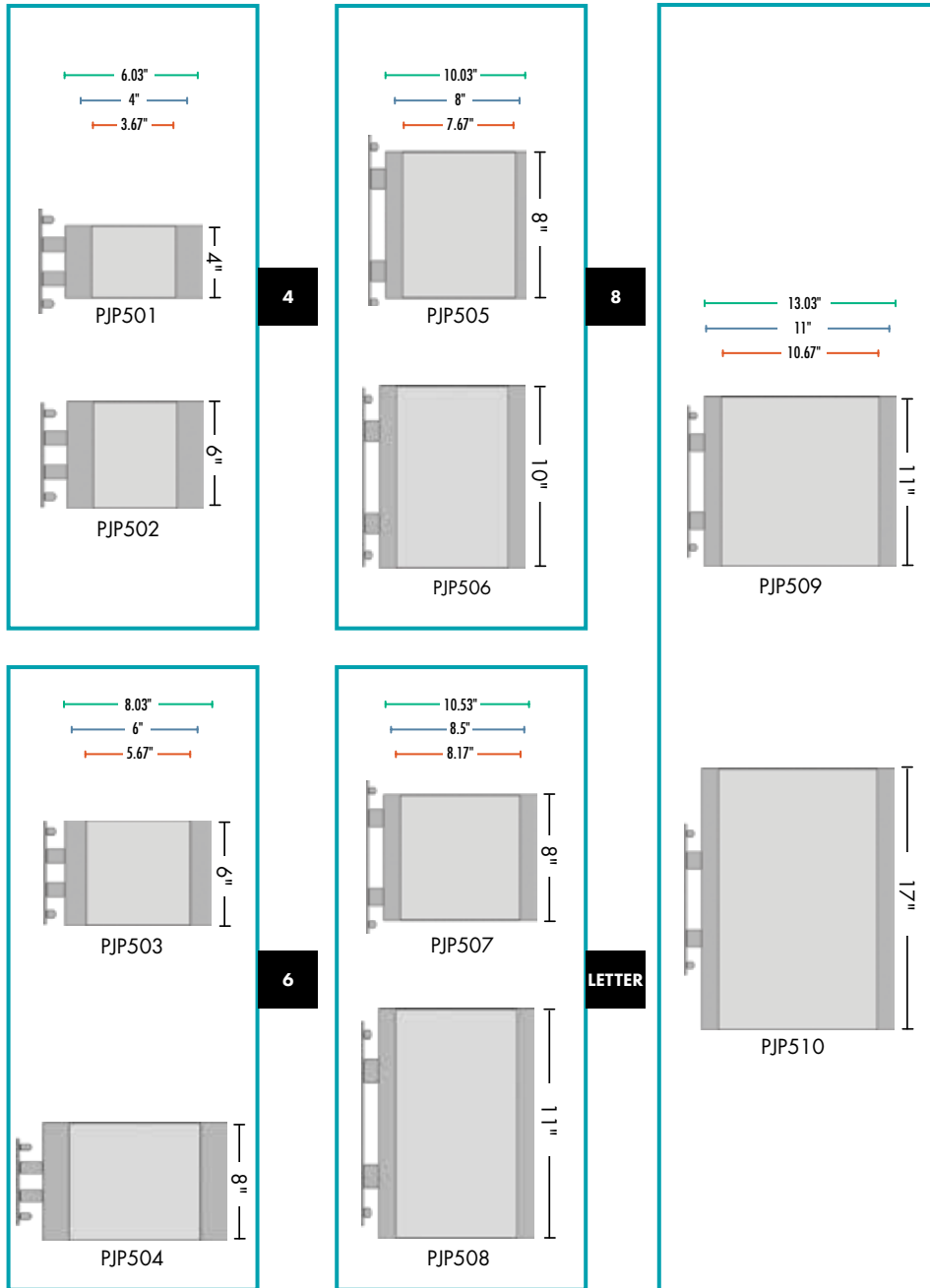

\\ Square Profile

\\ Black Finish

- \\ Double-sided flat projecting frames in portrait orientation
- \\ Frames located on left & right sides
- \\ Frame color choice of anodized silver or black
- \\ Frames offered in choice of round or square-shaped
- \\ End caps match the frame color of choice
- \\ Inserts can be replaced individually
- \\ Comes with non-glare lens, fully assembled
- \\ Custom sizes available

**TOP & BOTTOM
SUSPENDED**

■ Frame Size ■ Graphic Dims ■ Visible Area PREFIX: Add "FLAT-" to each listed code

4	20"	28"	32"
	SUSP501	SUSP502	SUSP503
	6.03" 3.77" 4" 4"		
6	22"	26"	34"
	SUSP504	SUSP505	SUSP506
	8.03" 5.67" 6" 6"		
8	20"	30"	38"
	SUSP507	SUSP508	SUSP509
	10.03" 7.67" 8" 8"		
LETTER	11"	25"	40"
	SUSP510	SUSP511	SUSP512
	10.53" 8.17" 8.5" 8.5"		
11	17"	24"	
	SUSP513	SUSP514	
	13.03" 10.67" 11" 11"		
17	24"	36"	48"
	SUSP515	SUSP516	SUSP517
	19.03" 16.67" 17" 17"		

- \\ Double-sided flat projecting frames in landscape orientation
- \\ Frames located on top & bottom offered in anodized silver or black
- \\ Frames offered in choice of round or square-shaped
- \\ End caps match the frame color of choice
- \\ Inserts can be replaced individually
- \\ Comes with non-glare lens, fully assembled
- \\ Custom sizes available

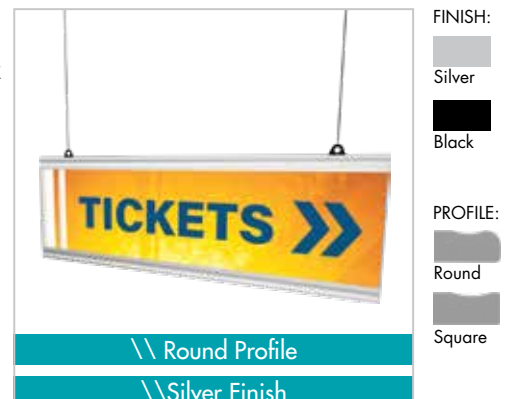

**TRIANGULAR
PROJECTING**

- \\ Triangular frame shape offered in choice of round or square-shaped
- \\ Frames located on the left & right sides
- \\ Configure the directory header to be placed as desired
- \\ Frame color choice of anodized silver or black
- \\ Inserts can be replaced individually
- \\ Custom sizes available

■ Frame Size ■ Graphic Dims ■ Visible Area

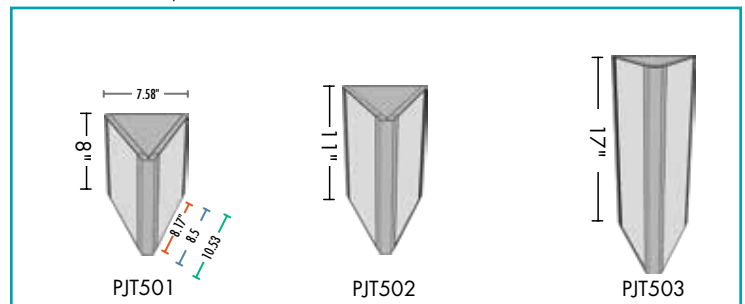

PREFIX: Add "FLAT-" to each listed code

DESK FRAMES

DESK

- \\ High quality standing desk frames with frames on left & right sides
- \\ Frame color choice of anodized silver or black
- \\ Frame shape offered in choice of round or square-shaped
- \\ Clear, non-glare lens and suction cup included
- \\ Custom sizes available

■ Frame Size ■ Graphic Dims ■ Visible Area PREFIX: Add "FLAT-" to each listed code

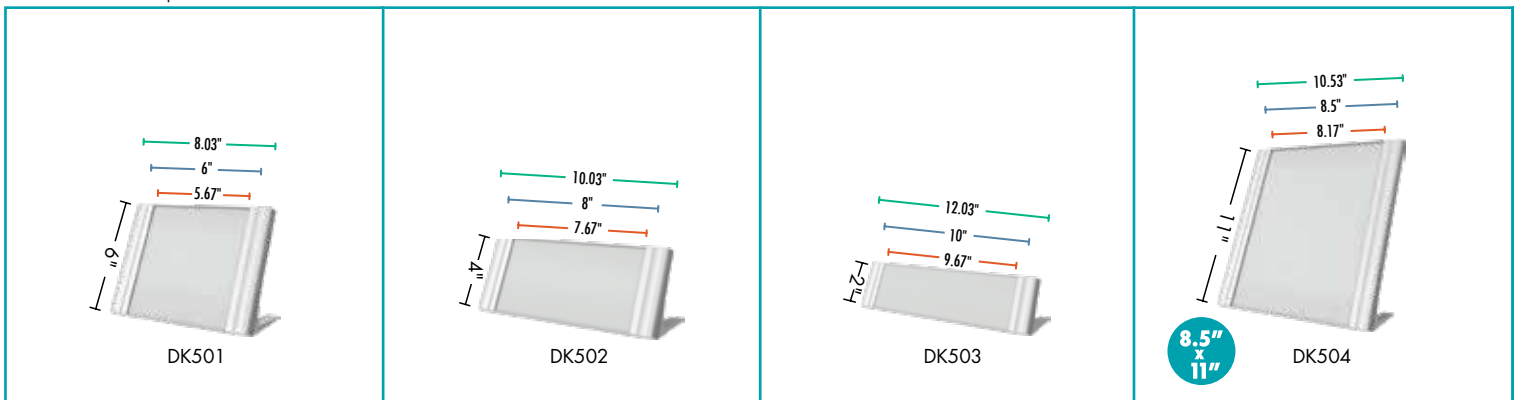



CURVED SYSTEM

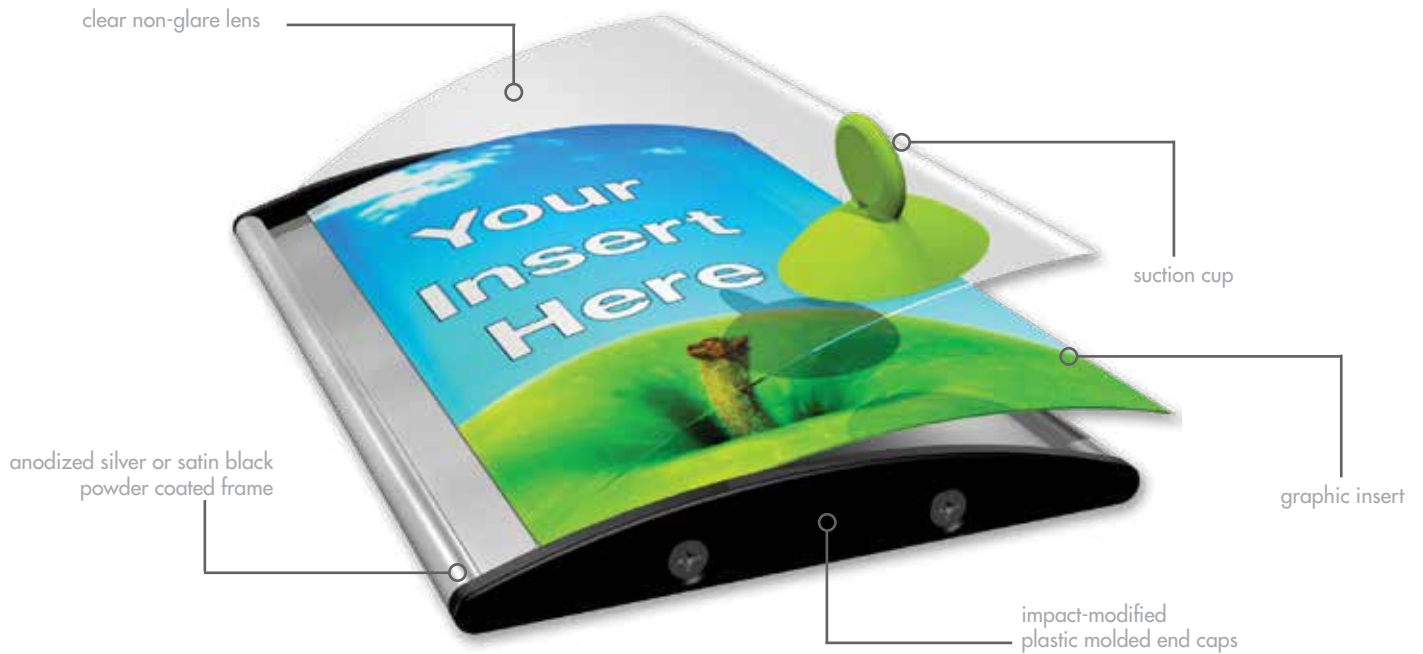

- \\ Aluminum frame extrusions are offered from 4" to 48" wide, at varying heights
- \\ Frames are available in anodized silver or powder coated black
- \\ Plastic end caps are offered in gray or black
- \\ Frames come standard with a clear, non-glare lens
- \\ Tape mounting included, holes are an additional cost
- \\ Custom lengths available



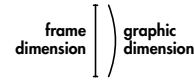

								2.36" 2-1/8"	60			
										3.93" 3-3/4"	100	
										4.72" 4-7/8"	120	
										5.90" 5-3/4"	150	
										7.87" 7-3/4"	200	
										8.64" 8-17/32"	LETTER	
										11.19" 11-1/16"	11	
											12.19" 12-1/16"	12
										17" 17"	17	
										18.19" 17-15/16"	18	
										24.0625" 24"	24	



blue insert slides left & right



partition pins used to secure frame to fabric wall

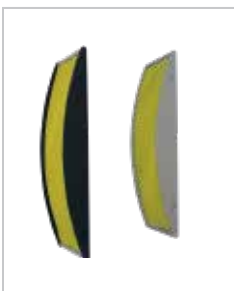

All length measurements apply to the extrusion only and exclude the end caps.

LEFT-TO-RIGHT WALL SIGNS

- \\ High quality, left-to-right curved frames
- \\ Frames are available in anodized silver or powder coated black
- \\ Frames come standard with a clear, non-glare lens
- \\ Tape mounting included, holes are an additional cost
- \\ Frames are ADA-compatible
- \\ Custom lengths available



comes fully assembled



graphic dimension

frame dimension

100	$3\text{-}\frac{3}{4}\text{'}$ 3.93" WP1	3' WP2	4' WP3	4.1875' 4' WP311	5' WP4	5.1875' 5' WP411	6' WP5	6.1875' 6' WP511	8' WP6				
120	$4\text{-}\frac{17}{32}\text{'}$ 4.72" WP7	3' WP8	4' WP9	4.1875' 4' WP91	5' WP10	5.1875' 5' WP101	6' WP11	6.1875' 6' WP111	7' WP12	8' WP13			
150	$5\text{-}\frac{3}{4}\text{'}$ 5.90" WP14	3' WP15	4' WP16	4.1875' 4' WP161	5' WP17	6' WP18	6.1875' 6' WP181	8' WP19	8.1875' 8' WP191	8.5' WP20	9' WP21		
200	$7\text{-}\frac{3}{4}\text{'}$ 7.87" WP22	4' WP23	4.1875' 4' WP231	5' WP24	6' WP25	6.1875' 6' WP251	8' WP26	8.1875' 8' WP261	10' WP27	10.1875' 10' WP271	12' WP28	16' WP29	18' WP30
LETTER	$8\text{-}\frac{17}{32}\text{'}$ 8.64" WP31	5.5' WP32	6' WP33	8' WP34	8.1875' 8' WP341	8.5' WP35	10' WP36	10.1875' 10' WP361	11' WP37	11.1875' 11' WP371	13.1875' 13' WP372	16' WP38	
11	$11\text{-}\frac{1}{16}\text{'}$ 11.19" WP40	8.5' WP41	8.6875' 8.5' WP4111	10' WP42	10.6875' 10.5' WP421	11' WP43	13' WP44	14' WP45	17' WP46	20' WP47			

All length measurements apply to the extrusion only and exclude the end caps.

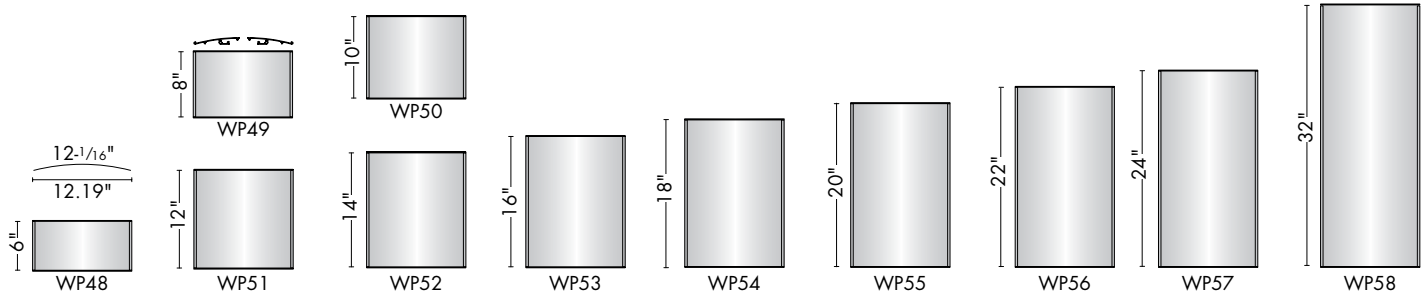

12

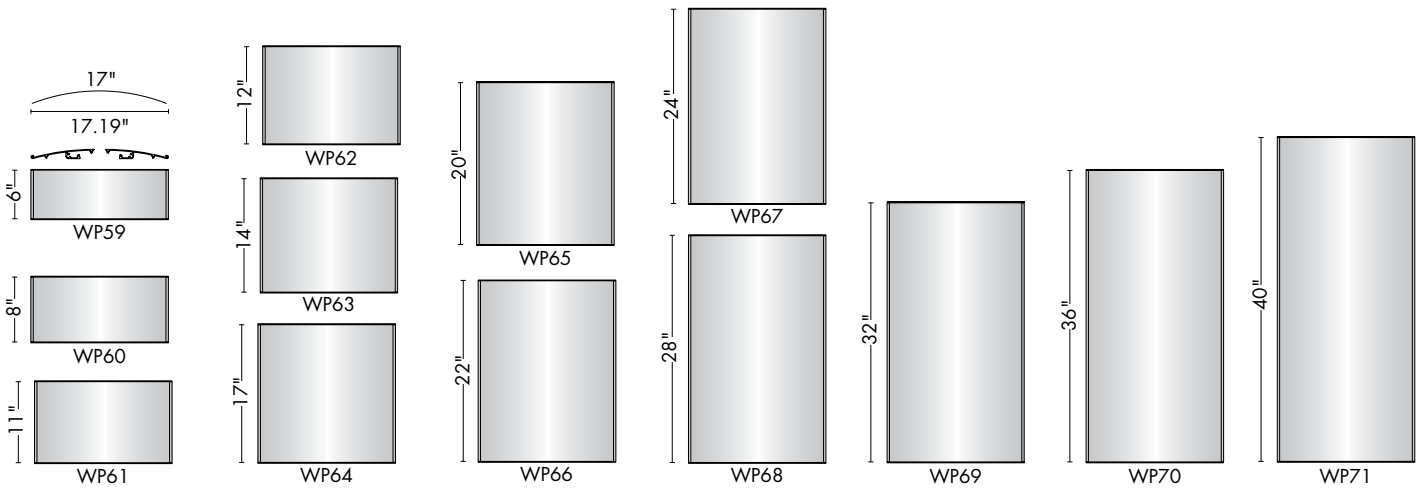

17

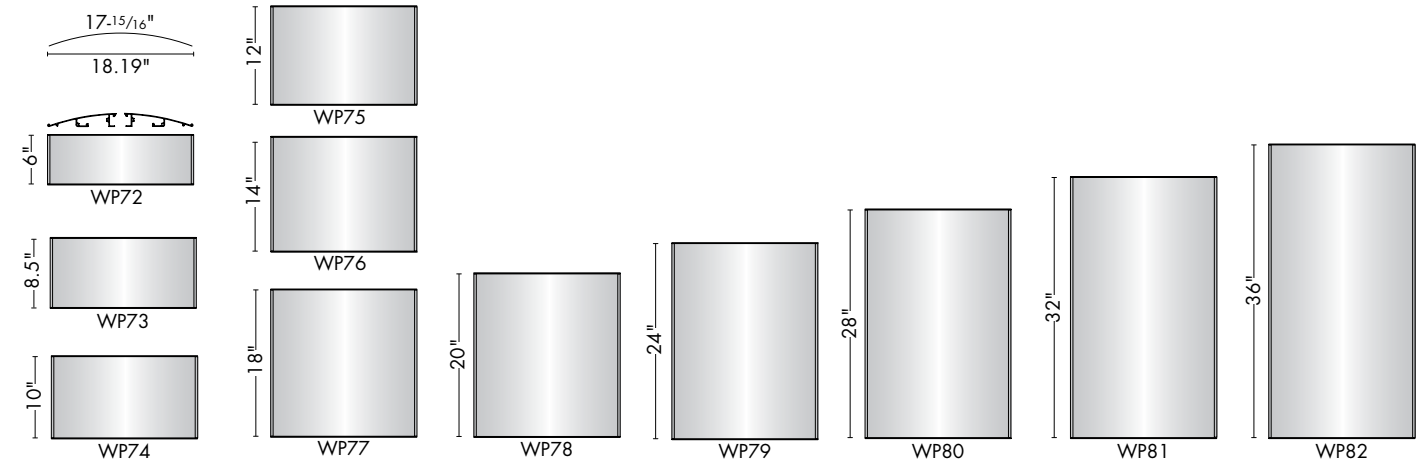

18

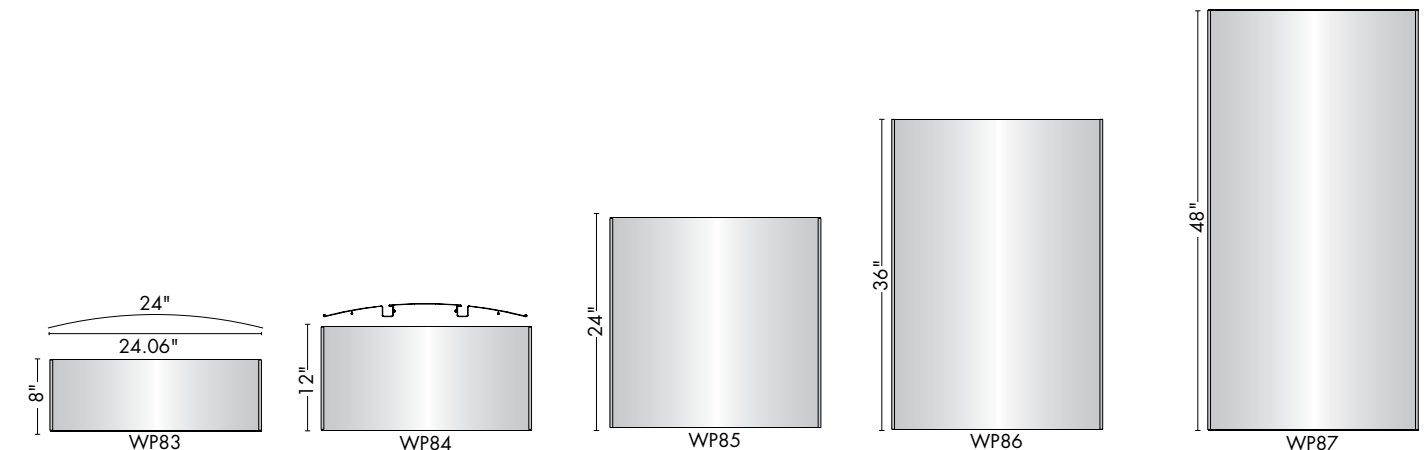

24

All length measurements apply to the extrusion only and exclude the end caps.

ADA lenses available for select wall frames only. Minimum of ten ADA lenses required per order.

DIRP SERIES
DIRECTORIES

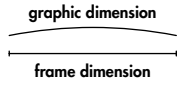

11

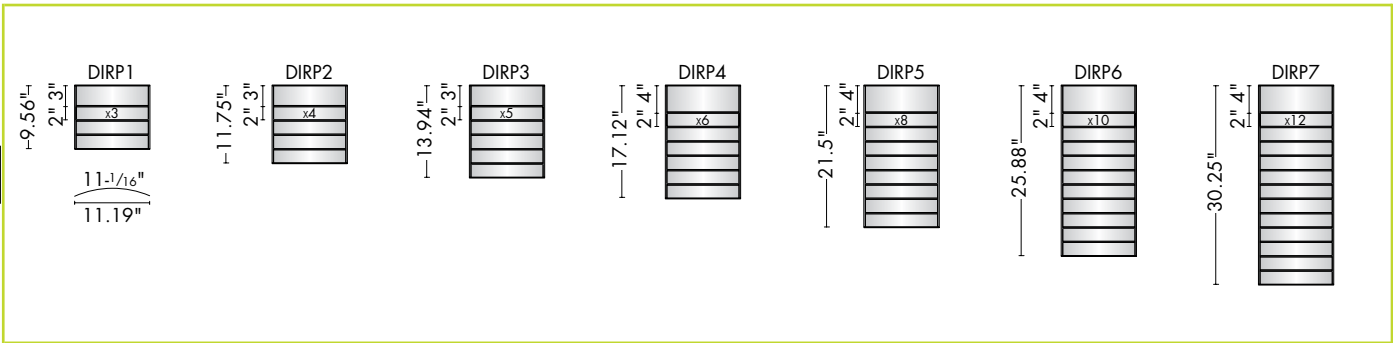

17

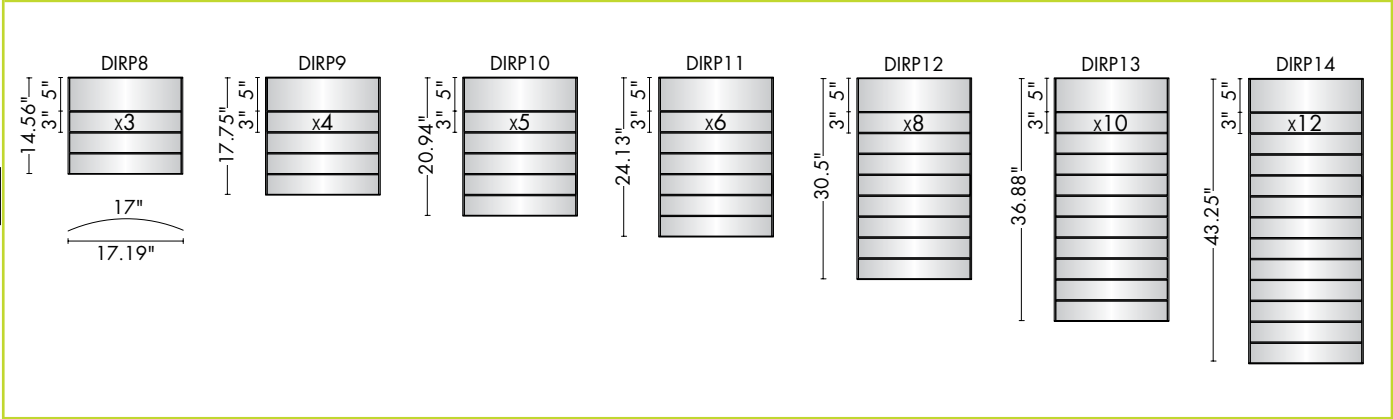

graphic is easily inserted before clear, non-glare lens

24

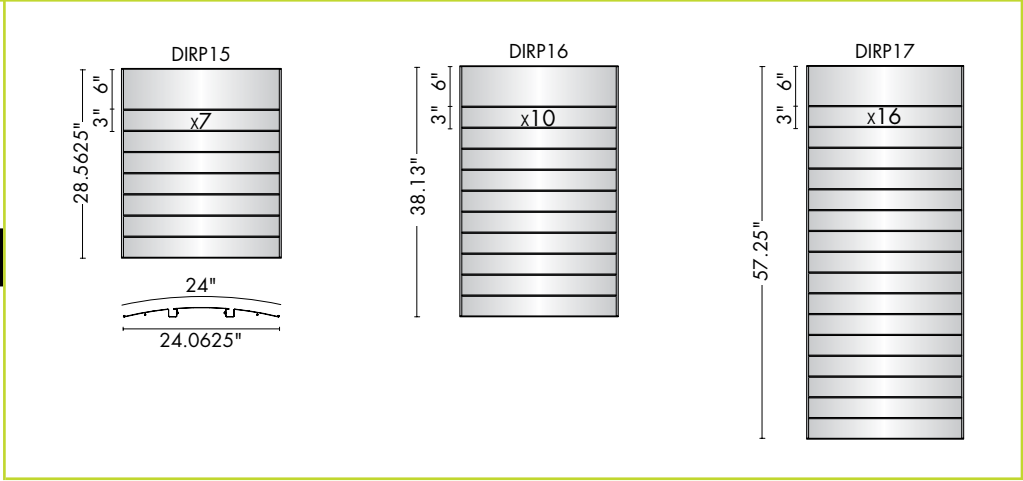

All length measurements apply to the extrusion only and exclude the end caps.

- \\ Dividing strips adhere to the frame and can be placed anywhere desired
- \\ End caps located on top & bottom
- \\ Inserts can be replaced individually
- \\ Custom frame combinations & lengths available



- \\ Combine multiple vertical frames with a top-to-bottom curve header
- \\ Vertical frames come with black dividing strips
- \\ Inserts can be replaced individually
- \\ Choice of black or gray end caps
- \\ Custom frame combinations & lengths available

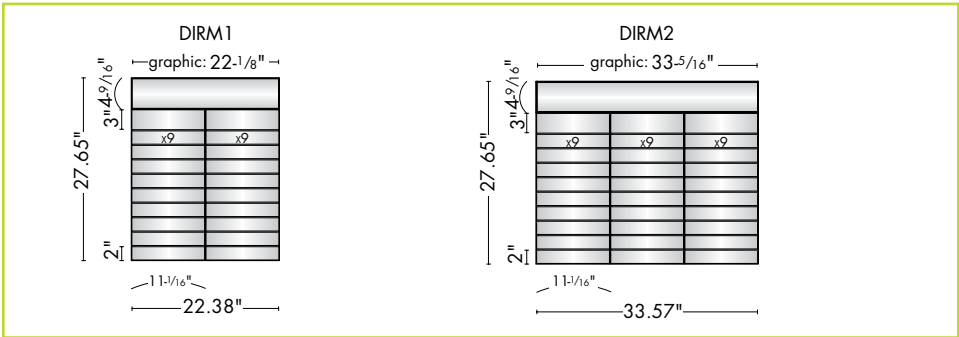

EAST WING LEVEL 1		
103	ADMINISTRATION	RESPIRATORY THERAPY 113
104	ADMISSIONS/CAJNER	REHABILITATION OFFICE 113
105	PATIENT RELATIONS OFFICE	PURCHASING/RECEIVING 114
106	PHARMACY	FAMILY WAITING ROOM 115
107	RADIOLOGY	ENVIRONMENTAL OFFICE 116
108	PHYSICAL THERAPY	SOCIAL SERVICES 117
109	ULTRASONOGRAPHY	Gift SHOP 118
110	PANORAMY	CAFE 119
111	CT SCAN	HUMAN RESOURCES 120

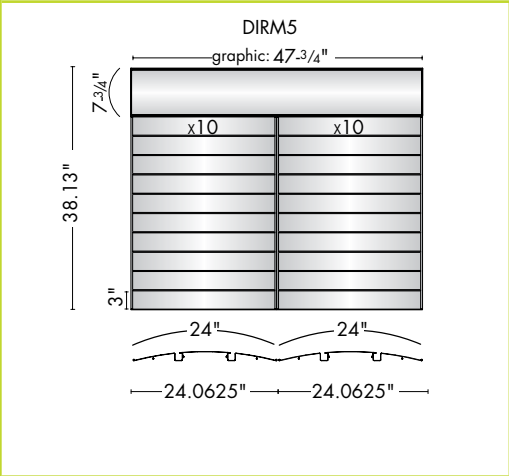
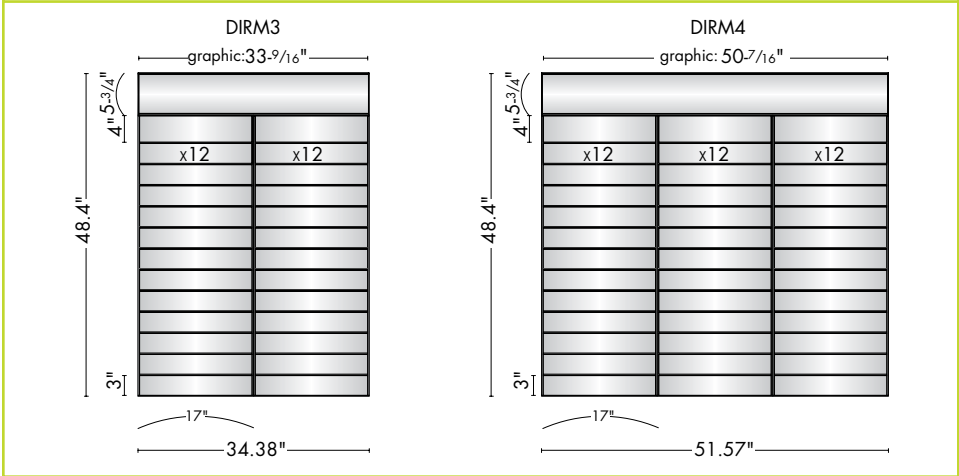

All length measurements apply to the extrusion only and exclude the end caps.

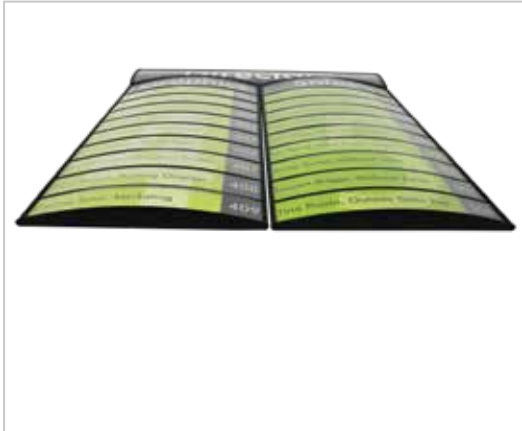

the non-glare lens is easily taken off with the suction cup for individual graphic replacement

DIRL SERIES

DIRECTORIES

- \\ Consists of multiple top-to-bottom curved frames combined
- \\ End caps on left & right sides
- \\ Comes as separate frames to mount to the wall individually
- \\ Choice of black or gray end caps
- \\ Custom frame combinations & lengths available

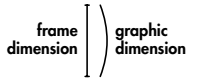

100	 DIRL1	 DIRL2	 DIRL3	
200	 DIRL4	 DIRL5	 DIRL6	
LETTER	 DIRL7	 DIRL8	 DIRL9	

All length measurements apply to the extrusion only and exclude the end caps.

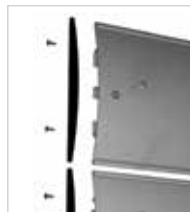

each frame allows for unique insert, available in custom widths up to 8'



the non-glare lens is easily taken off with the suction cup for individual graphic replacement



“This project was a great success. There is a sign type for every room and wayfinding location, and it was easy to customize and incorporate the signage into the entire design concept of the facility.”

photos courtesy of Fastsigns Lewiston

Tri-State Memorial Hospital

Signage Challenge

Tri-State Memorial Hospital was in need of a variable and consistent wayfinding and room identification system throughout the facility. The sign solution needed to offer a variety of functions, while remaining easy-to-read to assist doctors, patients and visitors in navigating the facility to different wings and specialty clinics.



photos courtesy of Signs Now #74

Signage Challenge

North Gibson School Corporation was in need of interior wayfinding signage for their high school to guide students, staff, and visitors to the right rooms and destinations.

“The outcome is effective and aesthetically pleasing to everyone who visits. The signage blends well. It directly guides visitors, students and staff to their intended destinations.”

PJL

PROJECTING

- \\ Double-sided, comes in landscape or portrait positions
- \\ End caps on left & right sides
- \\ Anodized silver or powder coated black frames
- \\ Choice of black or gray end caps
- \\ Comes with clear non-glare lens
- \\ Custom lengths available

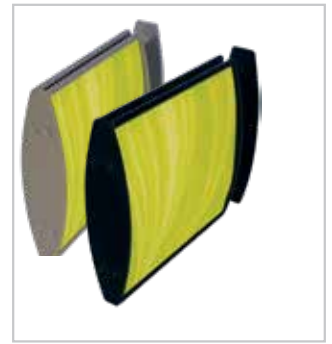

graphic dimension | frame dimension

100



150



200

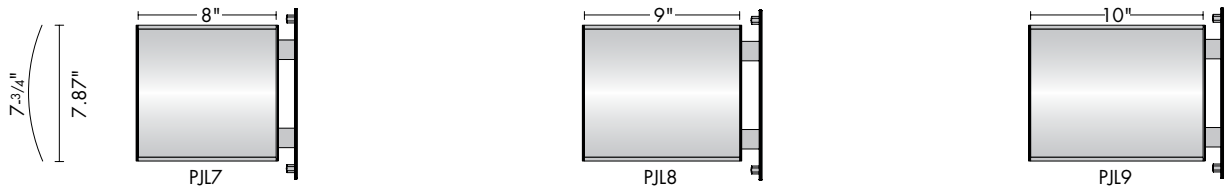

LETTER

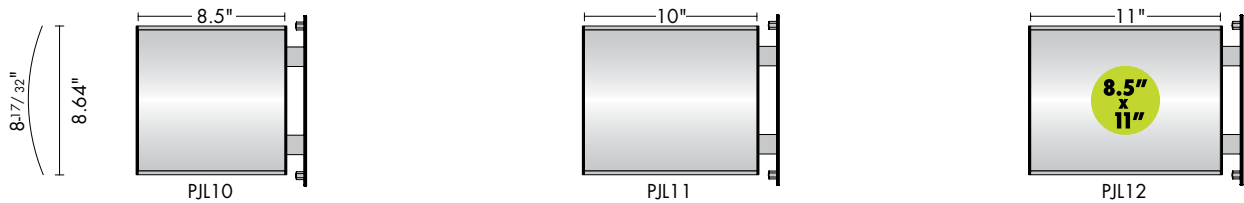

11

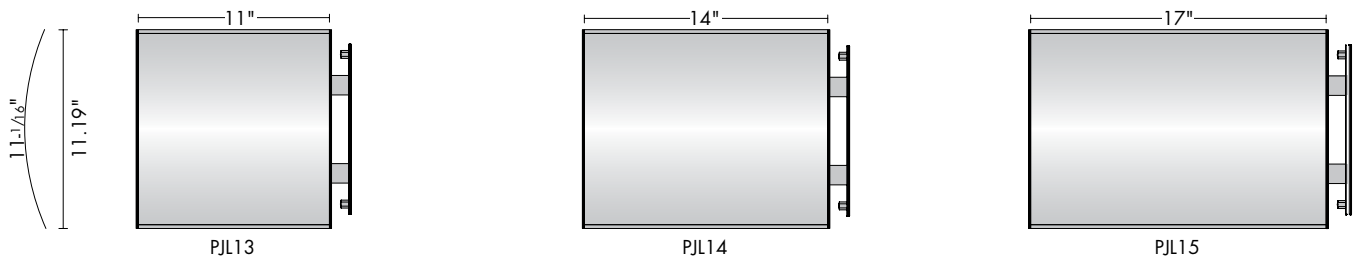

All length measurements apply to the extrusion only and exclude the end caps.

- \\ Flat, double-sided, projecting signs
- \\ Idea for cut vinyl applications
- \\ Sliver finish with black plastic end caps
- \\ Comes fully assembled
- \\ Custom lengths available

PJF
PROJECTING

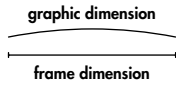

<p>PJF1</p>
<p>PJF2</p>
<p>PJF3</p>
<p>PJF4</p>
<p>PJF5</p>
<p>PJF6</p>

<p>3.3/4" 3.93"</p> <p>4.75" PJP1</p>	100
<p>5.5" PJP2</p>	

<p>7.3/4" 7.87"</p> <p>8" PJP5</p>	200
<p>10" PJP6</p>	

<p>11-1/16" 11.19"</p> <p>11" PJP9</p>	
<p>14" PJP10</p>	11

<p>5.3/4" 5.90"</p> <p>6" PJP3</p>	150
<p>6.75" PJP4</p>	

<p>8-17/32" 8.64"</p> <p>8" PJP7</p>	LETTER
<p>11" 8.5" x 11" PJP8</p>	

<p>17" PJP11</p>	
----------------------	--

All length measurements apply to the extrusion only and exclude the end caps.

TOP-TO-BOTTOM

SUSPENDED

- \\ Suspended signs combine back-to-back extrusions
- \\ Ideal for cut vinyl applications
- \\ Choice of black or gray end caps
- \\ Comes with clear non-glare lens, fully assembled
- \\ Custom lengths available



frame dimension | graphic dimension

60	SUSP1	SUSP2	SUSP3	SUSP4	
	2-1/8" (1) 2.36"	16"	20"	24"	
100	SUSP5	SUSP6	SUSP7	SUSP8	
	3-3/4" (1) 3.93"	24"	28"	32"	
120	SUSP9	SUSP10	SUSP11	SUSP12	
	4-17/32" (1) 4.72"	26"	30"	34"	
150	SUSP13	SUSP14	SUSP15	SUSP16	
	5-3/4" (1) 5.9"	28"	33"	38"	
200	SUSP17	SUSP18	SUSP19	SUSP20	
	7-3/4" (1) 7.87"	26"	32"	38"	
LETTER	SUSP21	SUSP22	SUSP23	SUSP24	
	8-17/32" (1) 8.64"	20"	25"	40"	
11	SUSP241	SUSP242	SUSP243	SUSP244	
	11-1/16" (1) 11.19"	17"	24"	36"	
17	SUSP245	SUSP246	SUSP247	SUSP248	SUSP249
	17" (1) 17.19"	24"	28"	36"	48"

All length measurements apply to the extrusion only and exclude the end caps.

<p>SUSP25 16" 2 1/8"</p>	<p>SUSP26 24" 2.36"</p>	<p>SUSP27 24" 2 1/8"</p>	<p>60</p> <p>60</p> <p>60</p>
<p>SUSP31 26" 4.72"</p>	<p>SUSP32 30" 4 17/32"</p>	<p>SUSP33 34" 4 17/32"</p>	<p>120</p> <p>120</p>
<p>SUSP34 28" 5.90"</p>	<p>SUSP35 34" 5 3/4"</p>	<p>SUSP36 38" 5 3/4"</p>	<p>150</p> <p>150</p>
<p>SUSP40 11" 8.5" x 11"</p>	<p>SUSP41 26" 8.64"</p>	<p>SUSP42 40" 8 17/32"</p>	<p>LETTER</p> <p>LETTER</p>
<p>SUSP46 20" 8.64"</p>	<p>SUSP47 25" 8 17/32"</p>	<p>SUSP48 30" 4 17/32"</p>	<p>LETTER</p> <p>120</p> <p>120</p>

All length measurements apply to the extrusion only and exclude the end caps.



24" left-to-right curve



17" left-to-right curve

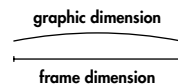

LEFT-TO-RIGHT

SUSPENDED

- \\ Available with a left-to-right curve orientation in both 24" and 17" widths
- \\ Combined with the height of your choice
- \\ Silver or black curved aluminum face, choice of black or grey end caps
- \\ Comes complete with a clear, non-glare lens
- \\ Comes fully assembled

PJT

TRIANGULAR

- \\ Triangular frames offered in two silver or black aluminum curved faces
- \\ Black powder-coated steel end caps
- \\ Mounting plates come standard with keyholes and round holes
- \\ Available in eight standard heights
- \\ Custom lengths available

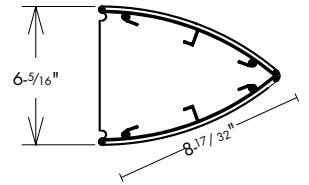

<p>PJT1</p>	<p>PJT2</p>	<p>PJT3</p>	<p>PJT4</p>	<p>PJT5</p>	<p>PJT6</p>	<p>PJT7</p>	<p>PJT8</p>
-------------	-------------	-------------	-------------	-------------	-------------	-------------	-------------

TR

TRIANGULAR

- \\ The triangular aluminum extruded body with impact-modified molded plastic end caps
- \\ Allows for wall or ceiling mount
- \\ Visible from two directions
- \\ Custom lengths available



<p>TR1</p>	<p>TR2</p>	<p>TR3</p>	<p>TR4</p>	<p>TR5</p>	<p>TR6</p>	<p>TR7</p>
------------	------------	------------	------------	------------	------------	------------

All length measurements apply to the extrusion only and exclude the end caps.

DKP SERIES

DESK

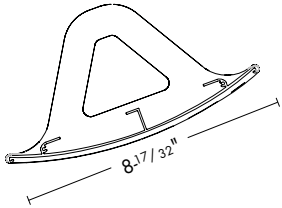

The **DKP series** of standing desk frames consists of high quality, powder-coated black anodized silver extruded aluminum body with a black plastic top cap and black steel foot plate. Its clear, non-glare lens and suction cup come standard. Custom lengths available.

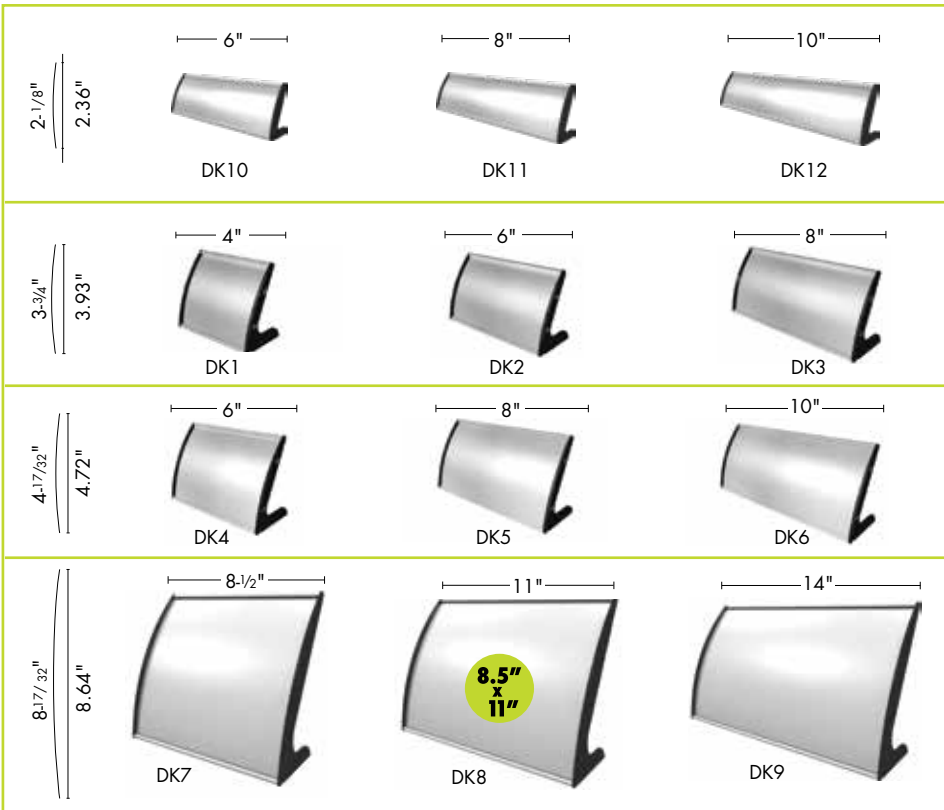
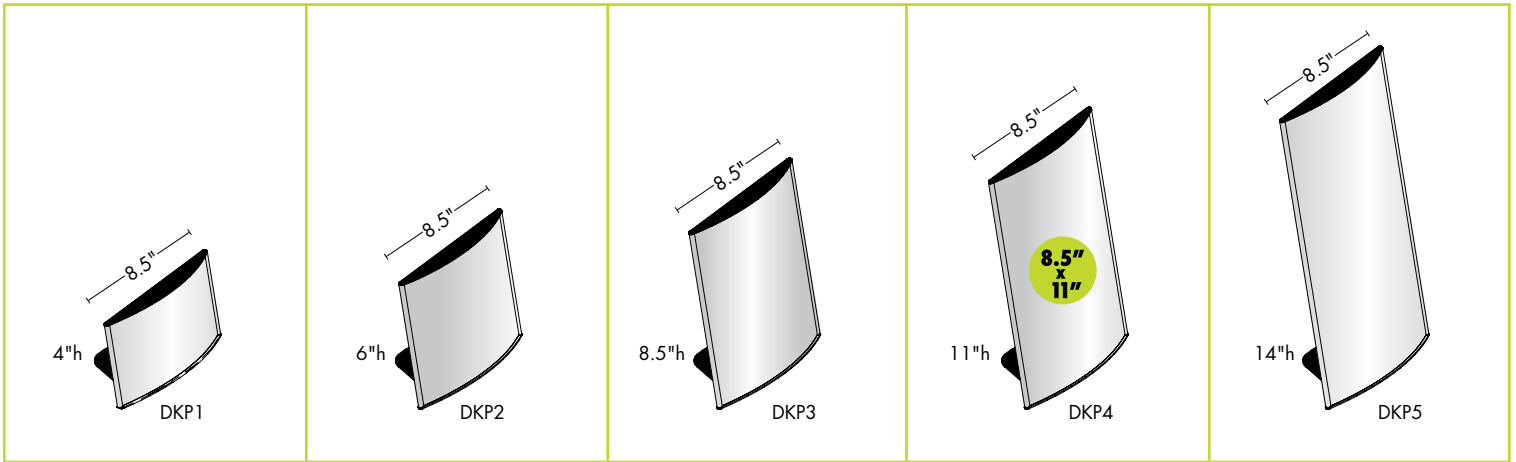

DK SERIES

DESK

60

100

120

LETTER



The **DK series** of standing desk frames offers impact-modified plastic molded end caps that double as feet for desk or table top use and a high quality, extruded aluminum body with anodized silver or satin powder-coated black finish. Clear, non-glare lens comes standard. Custom lengths available.

All length measurements apply to the extrusion only and exclude the end caps.

ACRYLIC

DESK

The **DKS** series of standing desk frames features two clear acrylic protective plates that protect your print and brushed silver aluminum support feet for a sharp and modern look. Comes in two standard sizes.

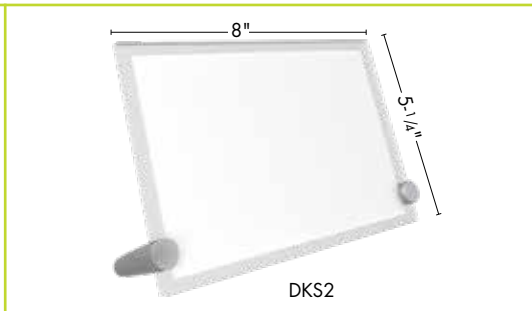
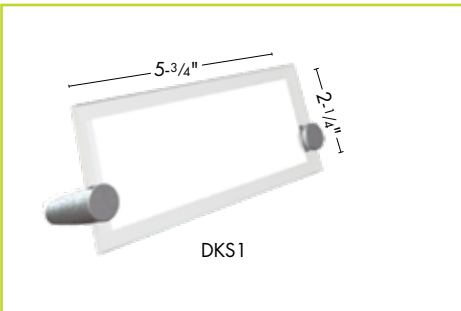

silver aluminum feet detach from clear acrylic plates for easy graphic insertion

CONCAVE

DESK

These sleekly designed **CONCAVE** desk frames are constructed of high-quality extruded aluminum. The lens slides in and out for easy print replacements. Comes standard in anodized silver or satin powder-coated black finish in two standard sizes.



Dimensions above are graphic sizes only.

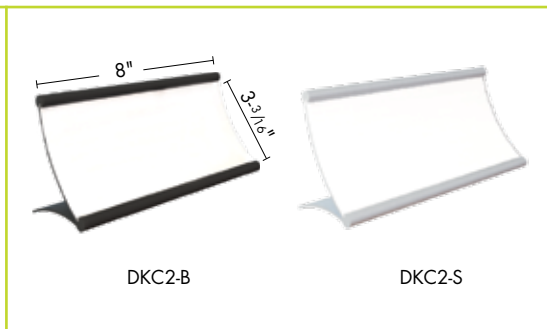
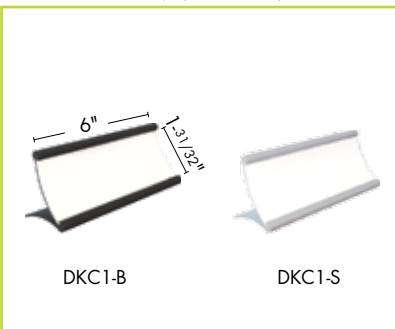

lens and graphic slide out for easy replacement

The **DKD** line of desk frames combines a stable domed, brushed silver aluminum holder with an elegant protective acrylic folded pocket providing a modern double-sided option and allows easy graphic changes. Comes in four standard sizes.

Dimensions above are graphic sizes only.

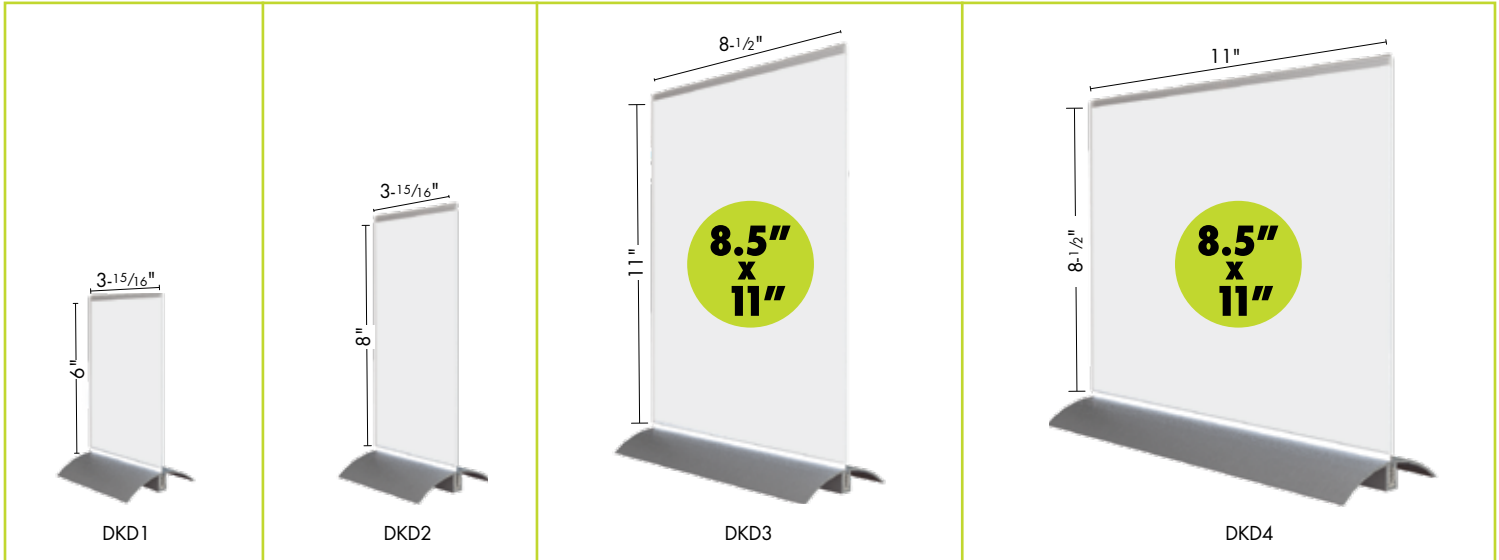

SIZE	PORTRAIT	LANDSCAPE	# OF SUPPORT FEET
8.5" x 11"	DKSNAP-1-P	DKSNAP-1-L	1
11" x 14"	DKSNAP-2-P	DKSNAP-2-L	1
11" x 17"	DKSNAP-11-P	DKSNAP-11-L	1
12" x 18"	DKSNAP-12-P	DKSNAP-12-L	1
14" x 22"	-	DKSNAP-3-L	2
16" x 20"	DKSNAP-4-P	DKSNAP-4-L	2
20" x 24"	-	DKSNAP-5-L	2

The **DK Snap** desk frames are available in a range of sizes and in black or silver. These front-loading desk frames snap open for quick and easy graphic changes. Includes clear non-glare protective lens.



SNAP-EDGE

TRAPPA

- \\ Silver or black anodized finish with precision mitered corners
- \\ Snaps open for quick and easy graphic changes
- \\ No tools required
- \\ Aluminum extrusions mounted to a high-impact polystyrene backer
- \\ Comes with clear non-glare lens, mounting hardware
- \\ Protective sheet material: PVC



Dimensions below refer to size of printed graphic only.

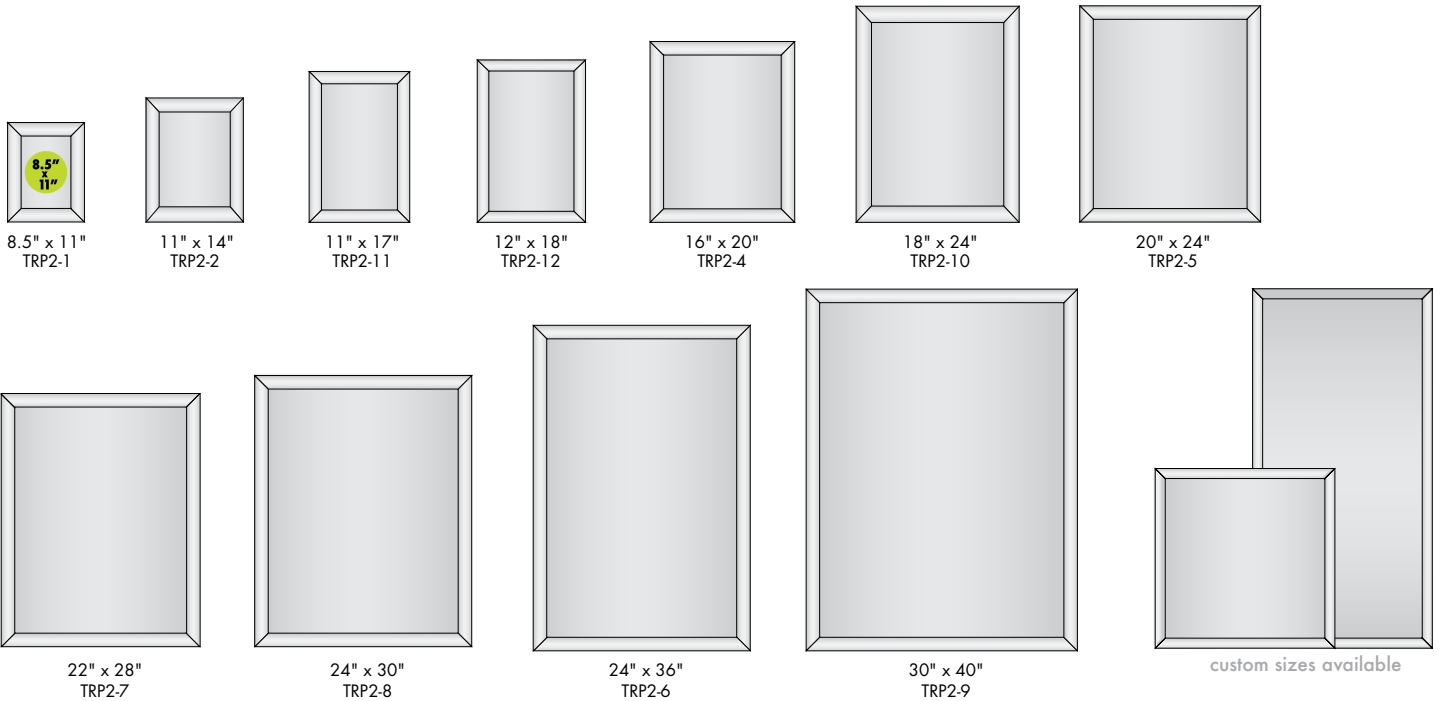

SNAP-EDGE

TRP CUSTOM

- \\ Trappa Poster Frame offers a simple, elegant snap rail solution for your custom-sized needs.
- \\ Combines two custom-length spring loaded snap rails with a backer
- \\ Comes with clear non-glare lens
- \\ Allows you to mount to a wall just by inserting the poster and snapping the edges shut
- \\ Rails, backer and lens are cut to size, depending on your graphic dimensions and desired rail length

SUGGESTED POPULAR SIZES

8.5" x 11"

11" x 17"

20" x 24"

22" x 28"

24" x 36"

24" x 48"

30" x 40"

36" x 52"



SNAP-LED

TRAPPA

- \\ 1" thick
- \\ 50,000 hr bulb life
- \\ Evenly distributed light
- \\ Snap frame allows easy graphic changes
- \\ Wall mounting hardware
- \\ Power supply with 78" cord
- \\ One year warranty

frame snaps open from the front



light box cord connects to wall adapter, illuminating the frame

CODE	SIZE
LED-SNAP-04	30"w x 40"h
LED-SNAP-05	36"w x 48"h

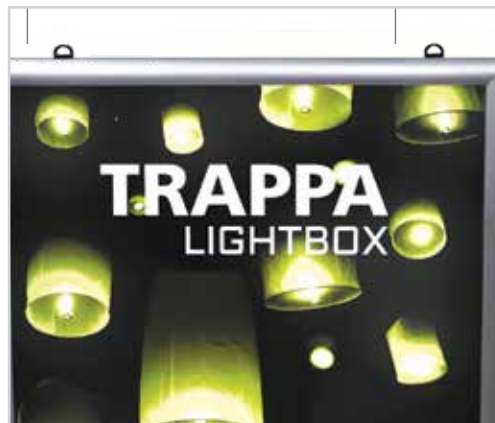

also available as hanging signs with our suspending clips



LED diffuser panel ensures even light distribution and brightness



POSTER SNAPPER

TRAPPA

- \\ Creates a clean, simple, elegant look
- \\ Hanging clips feature a top opening for clear nylon line mount as well as a recessed pocket for S-hook suspension
- \\ Adjustable hanging clips
- \\ Rails snap open and shut for quick graphic changes
- \\ Comes in four different standard widths: 24", 30", 36" and 48"
- \\ Custom-cut width available up to 60"

hanging options:

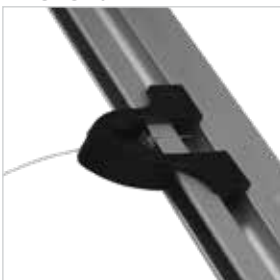

nylon line



S-hook



snap graphic rail for easy change-out



snap rail

PJ-SNAP

PROJECTING

- \\ Available in a wide range of sizes in black or silver
- \\ Double-sided projecting snap frames come with clear non-glare lenses
- \\ Fully assembled
- \\ Spring-loaded edges allows quick and easy graphic changes

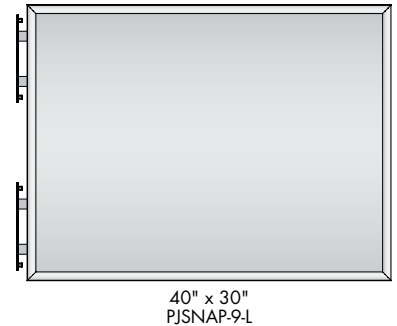
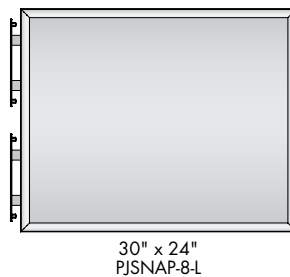
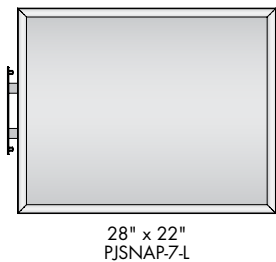
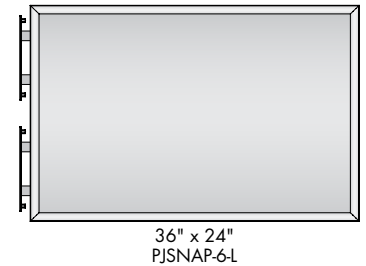
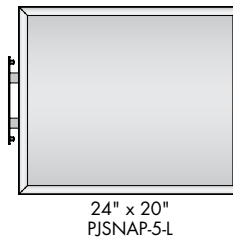
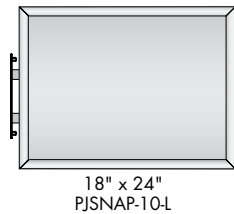
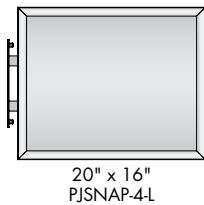
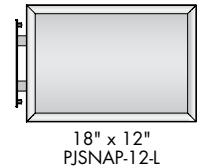
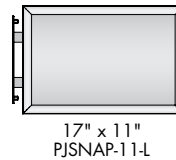
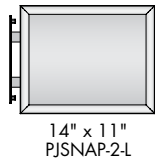
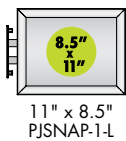
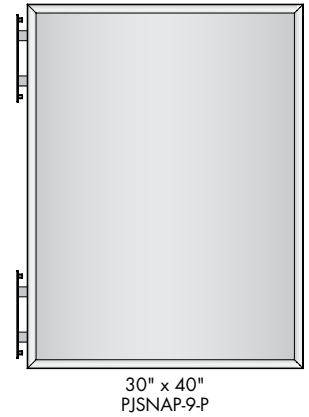
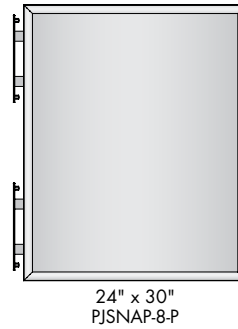
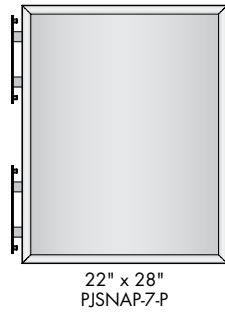
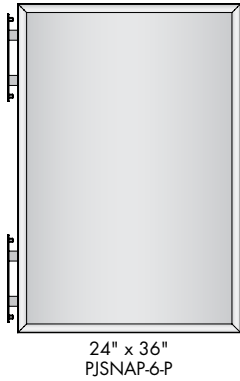
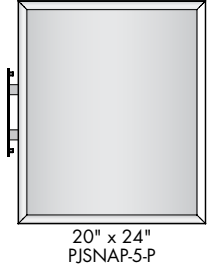
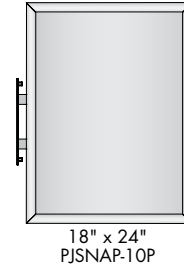
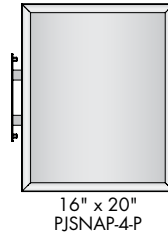
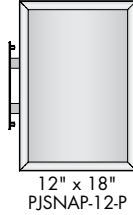
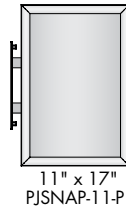
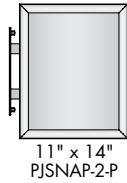
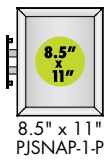
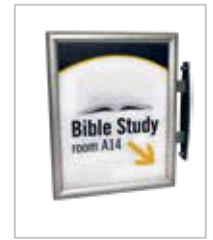

SUSP-SNAP

SUSPENDED



- \\ Available in a wide range of sizes in black or silver
- \\ Double-sided projecting snap frames come with clear non-glare lenses
- \\ Fully assembled



8.5" x 11"
SUSPSNAP-1-P



11" x 14"
SUSPSNAP-2-P

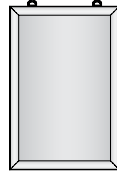

11" x 17"
SUSPSNAP-11-P

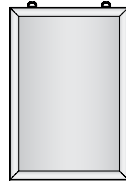

12" x 18"
SUSPSNAP-12-P

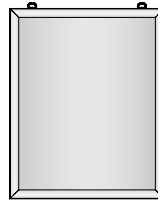

16" x 20"
SUSPSNAP-4-P



18" x 24"
SUSPSNAP-10-P

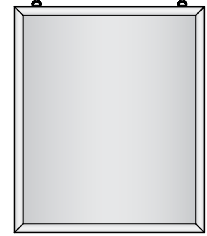

20" x 24"
SUSPSNAP-5-P



24" x 36"
SUSPSNAP-6-P



22" x 28"
SUSPSNAP-7-P

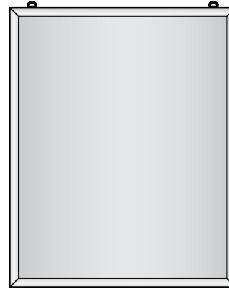

24" x 30"
SUSPSNAP-8-P

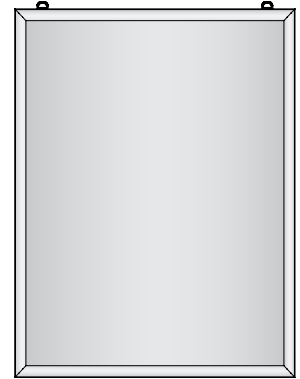

30" x 40"
SUSPSNAP-9-P

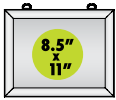

11" x 8.5"
SUSPSNAP-1-L

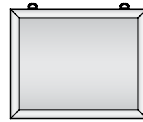

14" x 11"
SUSPSNAP-2-L

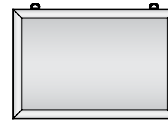

17" x 11"
SUSPSNAP-11-L

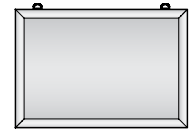

18" x 12"
SUSPSNAP-12-L

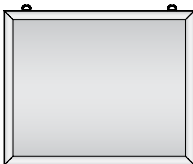

20" x 16"
SUSPSNAP-4-L



18" x 24"
SUSPSNAP-10-L

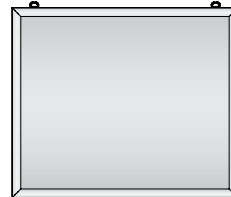

24" x 20"
SUSPSNAP-5-L

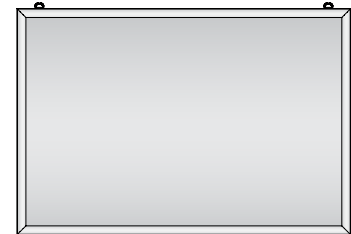

36" x 24"
SUSPSNAP-6-L

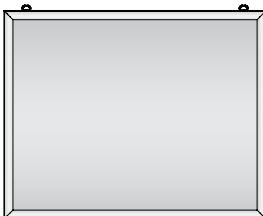

28" x 22"
SUSPSNAP-7-L

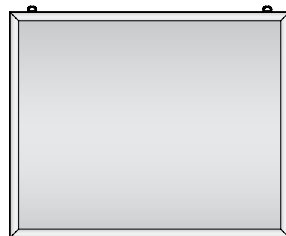

30" x 24"
SUSPSNAP-8-L

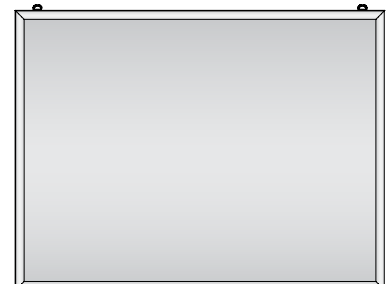

40" x 30"
SUSPSNAP-9-L

CASE STUDY

WAYFINDING

Wayfinding Signage Case Study

Laurel Toyota

“The results were fantastic! The professional staff of graphic designers and installers did a perfect job in all aspects of the project.”

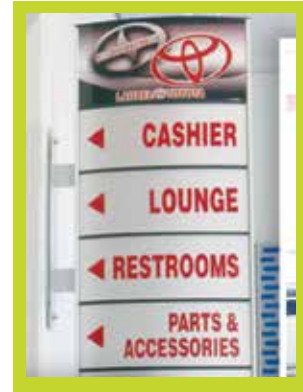

photos courtesy of Minahan Signs

Signage Challenge

Laurel Toyota was in need of directional and wayfinding signage to help clients feel welcome and comfortable navigating through the facility. Toyota was looking for an affordable solution, provided by a local contact they could constantly be in touch with.

Wayfinding Sign Solutions: Ideal for Churches, Hospitals and Schools

Wayfinding sign solutions are ideal to help visitors and staff of churches, hospitals, schools and more find their way and easily navigate the facility.



DISPLAYS

PYLONS

DISPLAYS

INFO CENTERS

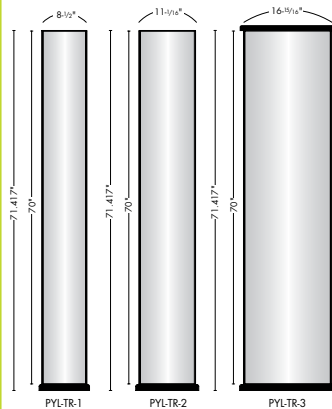
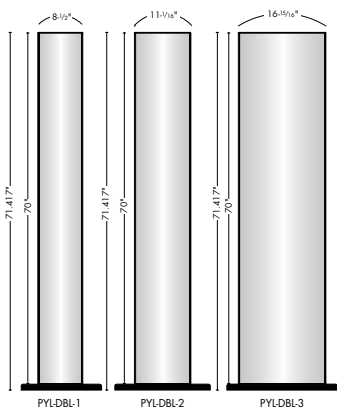

variable frame size options
add versatility

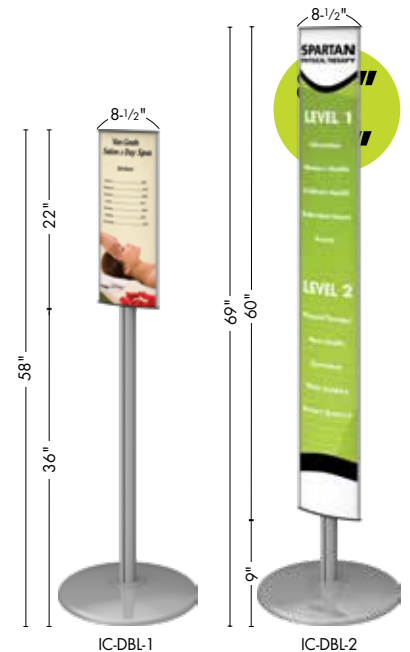

top view



top view

PYL-DBL Series

PYL-DBL

- \ \ Double-sided standing pylon display
- \ \ Choice of silver or black frames/extrusions
- \ \ Black laminate bottom plate with steel support plates
- \ \ Includes clear non-glare protective lenses
- \ \ Requires assembly

PYL-TR Series

PYL-TR

- \ \ Triangular shaped standing pylon display
- \ \ Choice of silver or black frames/extrusions
- \ \ Black laminate bottom plate with steel support plates
- \ \ Black powder coated steel top plate for PYL-TR1 & 2/Thermoformed plate on PYL-TR3
- \ \ Includes clear non-glare protective lenses
- \ \ Requires assembly

IC-TR Series

IC-TR

- \ \ Triangular shape
- \ \ Silver or black curved high quality aluminum extrusions
- \ \ Silver aluminum post, silver steel domed foot plate
- \ \ Black powder-coated steel top and bottom plate
- \ \ Clear non-glare protective lenses can be removed for a quick graphic change
- \ \ Custom heights available
- \ \ Requires assembly

IC-DBL Series

IC-DBL

- \ \ Silver or black curved high quality aluminum extrusions
- \ \ Silver aluminum post, silver steel domed foot plate
- \ \ Black powder-coated steel bottom plate, black molded plastic top plate
- \ \ Clear non-glare protective lenses can be removed for a quick graphic change
- \ \ Double sided
- \ \ Custom heights available
- \ \ Requires assembly

THE SIGN MAKERS'®
**HAND
BOOK**
WAYFINDING SYSTEMS

// **LET'S TALK!**



www.signmakershandbook.com

